



Member of **Sumitomo Drive Technologies**

OPTIDRIVE™

AC Variable Speed Drive

IP20

0.37kW – 37kW / 0.5HP – 50HP
110 – 480V Single and 3 Phase Input

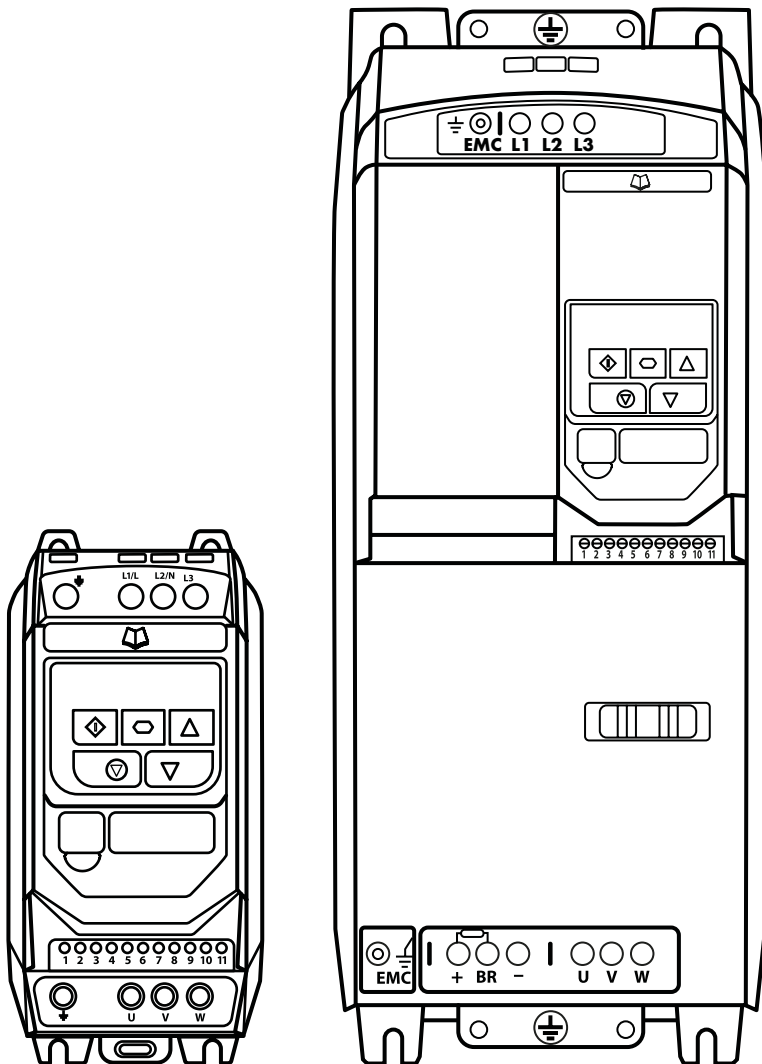

Quick Start Up	1
General Information and Ratings	2
Mechanical Installation	3
Power & Control Wiring	4
Operation	5
Parameters	6
Analog and Digital Input Macro Configurations	7
Modbus RTU Communications	8
Technical Data	9
Troubleshooting	10
Energy Efficiency Classification	11

1. Quick Start Up	4	6. Parameters	18
1.1. Important Safety Information.	4	6.1. Standard Parameters.	18
1.2. Quick Start Process.	5	6.2. Extended Parameters.	20
1.3. Installation Following a Period of Storage	6	6.3. Advanced Parameters.	24
2. General Information and Ratings	7	6.4. P-00 Read Only Status Parameters.	26
2.1. Identifying the Drive by Model Number.	7	7. Analog and Digital Input Macro Configurations. . .	27
2.2. Drive Model Numbers.	7	7.1. Overview.	27
3. Mechanical Installation	9	7.2. Example Connection Diagrams.	27
3.1. General.	9	7.3. Macro Functions Guide Key.	28
3.2. UL Compliant Installation.	9	7.4. Macro Functions – Terminal Mode (P-12 = 0)	29
3.3. Mechanical Dimensions and Mounting – IP20 Open Units ...	9	7.5. Macro Functions - Keypad Mode (P-12 = 1 or 2)	30
3.4. Guidelines for Enclosure Mounting	10	7.6. Macro Functions - Fieldbus Control Mode (P-12 = 3, 4, 7, 8 or 9)	30
4. Power & Control Wiring	11	7.7. Macro Functions - User PI Control Mode (P-12 = 5 or 6) ..	31
4.1. Connection Diagram.	11	7.8. Fire Mode.	31
4.2. Protective Earth (PE) Connection.	11	8. Modbus RTU Communications	32
4.3. Incoming Power Connection.	12	8.1. Introduction.	32
4.4. Motor Connection.	12	8.2. Modbus RTU Specification.	32
4.5. Motor Terminal Box Connections.	13	8.3. RJ45 Connector Configuration.	32
4.6. Control Terminal Wiring.	13	8.4. Modbus Register Map.	32
4.7. Control Terminal Connections.	13	9. Technical Data	36
4.8. Motor Thermal Overload Protection.	14	9.1. Environmental.	36
4.9. EMC Compliant Installation.	15	9.2. Rating Tables.	36
4.10. Optional Brake Resistor.	15	9.3. Single Phase Operation of Three Phase Drives	37
5. Operation	16	9.4. Additional Information for UL Compliance.	37
5.1. Managing the Keypad.	16	9.5. EMC Filter Disconnect.	38
5.2. Operating Displays.	16	10. Troubleshooting	39
5.3. Changing Parameters.	16	10.1. Fault Code Messages.	39
5.4. Read Only Parameter Access.	17	11. Energy Efficiency Classification	40
5.5. Resetting Parameters.	17		
5.6. Resetting a Fault.	17		
5.7. LED Display.	17		

General Information

It is the responsibility of the installer to ensure that the equipment or system into which the product is incorporated complies with all relevant legislation and codes of practice which apply in the country of use.

CE Marking

All Invertek Drives products intended for use within the European Union carry the CE mark to indicate compliance with European Directives.

A declaration of conformity is available from the website, www.invertekdrives.com

For compliance with the European EMC Directive, the necessary guidance is provided within this document and it is the responsibility of the installer to ensure this guidance is followed to ensure compliance.

UL Conformity

A list of currently listed products is available from the UL website, www.ul.com.

For compliance with UL requirements, the necessary guidance is provided within this document and it is the responsibility of the installer to ensure this guidance is followed to ensure compliance.

Copyright Invertek Drives Ltd © 2022

All rights reserved. No part of this User Guide may be reproduced or transmitted in any form or by any means, electrical or mechanical including photocopying, recording or by any information storage or retrieval system without permission in writing from the publisher.

2 Year Warranty

All Invertek Optidrive units carry a 2 year warranty against manufacturing defects from the date of manufacture. The manufacturer accepts no liability for any damage caused during or resulting from transport, receipt of delivery, installation or commissioning. The manufacturer also accepts no liability for damage or consequences resulting from inappropriate, negligent or incorrect installation, incorrect adjustment of the operating parameters of the drive, incorrect matching of the drive to the motor, incorrect installation, unacceptable dust, moisture, corrosive substances, excessive vibration or ambient temperatures outside of the design specification.

The local distributor may offer different terms and conditions at their discretion, and in all cases concerning warranty, the local distributor should be contacted first.





This user guide is the “original instructions” document. All non-English versions are translations of the “original instructions”.

The contents of this User Guide are believed to be correct at the time of printing. In the interest of a commitment to a policy of continuous improvement, the manufacturer reserves the right to change the specification of the product or its performance or the contents of the User Guide without notice.

This User Guide is for use with version 3.11 Firmware

User Guide Revision 1.04

Invertek Drives Ltd adopts a policy of continuous improvement and whilst every effort has been made to provide accurate and up to date information, the information contained in this User Guide should be used for guidance purposes only and does not form the part of any contract.

	When installing the drive on any power supply where the phase-ground voltage may exceed the phase-phase voltage (typically IT supply networks or Marine vessels) it is essential that the internal EMC filter ground and surge protection varistor ground (where fitted) are disconnected. If in doubt, refer to your Sales Partner for further information.
	This manual is intended as a guide for proper installation. Invertek Drives Ltd cannot assume responsibility for the compliance or the non-compliance to any code, national, local or otherwise, for the proper installation of this drive or associated equipment. A hazard of personal injury and/or equipment damage exists if codes are ignored during installation.
	This Optidrive contains high voltage capacitors that take time to discharge after removal of the main supply. Before working on the drive, ensure isolation of the main supply from line inputs. Wait ten (10) minutes for the capacitors to discharge to safe voltage levels. Failure to observe this precaution could result in severe bodily injury or loss of life.
	Only qualified electrical personnel familiar with the construction and operation of this equipment and the hazards involved should install, adjust, operate, or service this equipment. Read and understand this manual and other applicable manuals in their entirety before proceeding. Failure to observe this precaution could result in severe bodily injury or loss of life.

1. Quick Start Up

1.1. Important Safety Information

Please read the IMPORTANT SAFETY INFORMATION below, and all Warning and Caution information elsewhere.



Danger: Indicates a risk of electric shock, which, if not avoided, could result in damage to the equipment and possible injury or death.

This variable speed drive product (Optidrive) is intended for professional incorporation into complete equipment or systems as part of a fixed installation. If installed incorrectly it may present a safety hazard. The Optidrive uses high voltages and currents, carries a high level of stored electrical energy, and is used to control mechanical plant that may cause injury. Close attention is required to system design and electrical installation to avoid hazards in either normal operation or in the event of equipment malfunction. Only qualified electricians are allowed to install and maintain this product.

System design, installation, commissioning and maintenance must be carried out only by personnel who have the necessary training and experience. They must carefully read this safety information and the instructions in this Guide and follow all information regarding transport, storage, installation and use of the Optidrive, including the specified environmental limitations.

Do not perform any flash test or voltage withstand test on the Optidrive. Any electrical measurements required should be carried out with the Optidrive disconnected.

Electric shock hazard! Disconnect and ISOLATE the Optidrive before attempting any work on it. High voltages are present at the terminals and within the drive for up to 10 minutes after disconnection of the electrical supply. Always ensure by using a suitable multimeter that no voltage is present on any drive power terminals prior to commencing any work.

Where supply to the drive is through a plug and socket connector, do not disconnect until 10 minutes have elapsed after turning off the supply.

Ensure correct earthing connections. The earth cable must be sufficient to carry the maximum supply fault current which normally will be limited by the fuses or MCB. Suitably rated fuses or MCB should be fitted in the mains supply to the drive, according to any local legislation or codes.

Ensure correct earthing connections and cable selection as per defined by local legislation or codes. The drive may have a leakage current of greater than 3.5mA; furthermore the earth cable must be sufficient to carry the maximum supply fault current which normally will be limited by the fuses or MCB. Suitably rated fuses or MCB should be fitted in the mains supply to the drive, according to any local legislation or codes.

Do not carry out any work on the drive control cables whilst power is applied to the drive or to the external control circuits.



Danger: Indicates a potentially hazardous situation other than electrical, which if not avoided, could result in damage to property.

Within the European Union, all machinery in which this product is used must comply with Directive 2006/42/EC, Safety of Machinery. In particular, the machine manufacturer is responsible for providing a main switch and ensuring the electrical equipment complies with EN60204-1.

The level of integrity offered by the Optidrive control input functions – for example stop/start, forward/reverse and maximum speed is not sufficient for use in safety-critical applications without independent channels of protection. All applications where malfunction could cause injury or loss of life must be subject to a risk assessment and further protection provided where needed.

The driven motor can start at power up if the enable input signal is present.

The STOP function does not remove potentially lethal high voltages. ISOLATE the drive and wait 10 minutes before starting any work on it. Never carry out any work on the Drive, Motor or Motor cable whilst the input power is still applied.

The Optidrive can be programmed to operate the driven motor at speeds above or below the speed achieved when connecting the motor directly to the mains supply. Obtain confirmation from the manufacturers of the motor and the driven machine about suitability for operation over the intended speed range prior to machine start up.

Do not activate the automatic fault reset function on any systems whereby this may cause a potentially dangerous situation.

Optidrives are intended for indoor use only.

When mounting the drive, ensure that sufficient cooling is provided. Do not carry out drilling operations with the drive in place, dust and swarf from drilling may lead to damage.

The entry of conductive or flammable foreign bodies should be prevented. Flammable material should not be placed close to the drive

Relative humidity must be less than 95% (non-condensing).

Ensure that the supply voltage, frequency and no. of phases (1 or 3 phase) correspond to the rating of the Optidrive as delivered.

Never connect the mains power supply to the Output terminals U, V, W.

Do not install any type of automatic switchgear between the drive and the motor.

Wherever control cabling is close to power cabling, maintain a minimum separation of 100 mm and arrange crossings at 90 degrees. Ensure that all terminals are tightened to the appropriate torque setting.

Do not attempt to carry out any repair of the Optidrive. In the case of suspected fault or malfunction, contact your local Invertek Drives Sales Partner for further assistance.

1.2. Quick Start Process

Step	Action	See section	Page
1	Identify the Enclosure Type, Model Type and ratings of your drive from the model code on the label. In particular - Check the voltage rating suits the incoming supply - Check the output current capacity meets or exceeds the full load current for the intended motor	2.1. Identifying the Drive by Model Number	7
2	Unpack and check the drive. Notify the supplier and shipper immediately of any damage.		
3	Ensure correct ambient and environmental conditions for the drive are met by the proposed mounting location.	9.1. Environmental	36
4	Install the drive in a suitable cabinet (IP20 Units) ensuring suitable cooling air is available.	3.1. General 3.3. Mechanical Dimensions and Mounting – IP20 Open Units 3.4. Guidelines for Enclosure Mounting	9 9 10
5	Select the correct power and motor cables according to local wiring regulations or code, noting the maximum permissible sizes	9.2. Rating Tables	36
6	If the supply type is IT or corner grounded, disconnect the EMC filter before connecting the supply.	9.5. EMC Filter Disconnect	38
7	Check the supply cable and motor cable for faults or short circuits.		
8	Route the cables.		
9	Check that the intended motor is suitable for use, noting any precautions recommended by the supplier or manufacturer.	4.9. EMC Compliant Installation	15
10	Check the motor terminal box for correct Star or Delta configuration where applicable.	4.5. Motor Terminal Box Connections	13
11	Ensure wiring protection is providing, by installing a suitable circuit breaker or fuses in the incoming supply line.	4.3.2. Fuse / Circuit Breaker Selection 9.2. Rating Tables	12 36
12	Connect the power cables, especially ensuring the protective earth connection is made.	4.1. Connection Diagram 4.2. Protective Earth (PE) Connection 4.3. Incoming Power Connection 4.4. Motor Connection	11 11 12 12
13	Connect the control cables as required for the application.	4.6. Control Terminal Wiring 4.9. EMC Compliant Installation 7. Analog and Digital Input Macro Configurations 7.2. Example Connection Diagrams	13 15 27 27
14	Thoroughly check the installation and wiring.		
15	Commission the drive parameters.	5.1. Managing the Keypad 6. Parameters	16 18

1.3. Installation Following a Period of Storage

Where the drive has been stored for some time prior to installation, or has remained without the main power supply present for an extended period of time, it is necessary to reform the DC capacitors within the drive according to the following table before operation. For drives which have not been connected to the main power supply for a period of more than 2 years, this requires a reduced mains voltage to be applied for a time period, and gradually increased prior to operating the drive. The voltage levels relative to the drive rated voltage, and the time periods for which they must be applied are shown in the following table. Following completion of the procedure, the drive may be operated as normal.

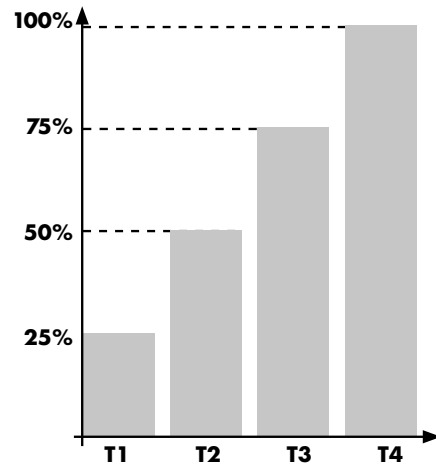

Storage Period / Power-OFF Period	Initial Input Voltage Level	Time Period T1	Secondary Input Voltage Level	Time Period T2	Third Input Voltage Level	Time Period T3	Final Input Voltage Level	Time Period T4
Up to 1 Year	100%	N/A						
1 – 2 Years	100%	1 Hour	N/A					
2 – 3 Years	25%	30 Minutes	50%	30 Minutes	75%	30 Minutes	100%	30 Minutes
More than 3 Years	25%	2 Hours	50%	2 Hours	75%	2 Hours	100%	2 Hours

1.4. Quick Start Overview

Quick Start – IP20

- Connect a Start / Stop switch between control terminals 1 & 2
 - Close the Switch to Start
 - Open to Stop
- Connect a potentiometer (5k – 10kΩ) between terminals 5, 6 and 7 as shown
 - Adjust the potentiometer to vary the speed from P-02 (0Hz default) to P-01 (50 / 60 Hz default)

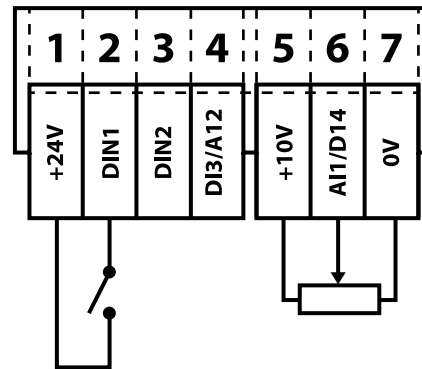

2. General Information and Ratings

This chapter contains information about the Optidrive E3 including how to identify the drive.

2.1. Identifying the Drive by Model Number

Each drive can be identified by its model number, as shown in the table below. The model number is on the shipping label and the drive nameplate. The model number includes the drive and any options.

	ODE	-	3	-	1	2	0021	-	1	F	1	2		
Product Family													IP Rating	2 = IP20
Generation													Dynamic Brake Transistor	1 = Not Fitted 4 = Internal Transistor
Frame Size													Filter Type	0 = No Filter F = Internal EMC Filter
Input Voltage	1 = 110 – 115 2 = 200 – 240 4 = 380 – 480												No. Of Input Phases	Output Current x 10

2.2. Drive Model Numbers

110 – 115V ± 10% - 1 Phase Input – 3 Phase 230V Output (Voltage Doubler)					
Model Number		kW	HP	Output Current (A)	Frame Size
With Filter	Without Filter				
N/A	ODE-3-110023-1012		0.5	2.3	1
N/A	ODE-3-110043-1012		1	4.3	1
N/A	ODE-3-210058-1042		1.5	5.8	2
200 – 240V ± 10% - 1 Phase Input – 3 Phase Output					
Model Number		kW	HP	Output Current (A)	Frame Size
With Filter	Without Filter				
ODE-3-120023-1F12	ODE-3-120023-1012	0.37	0.5	2.3	1
ODE-3-120043-1F12	ODE-3-120043-1012	0.75	1	4.3	1
ODE-3-120070-1F12	ODE-3-120070-1012	1.5	2	7	1
ODE-3-220070-1F42	ODE-3-220070-1042	1.5	2	7	2
ODE-3-220105-1F42	ODE-3-220105-1042	2.2	3	10.5	2
N/A	ODE-3-320153-1042	4.0	5	15.3	3
200 – 240V ± 10% - 3 Phase Input – 3 Phase Output					
Model Number		kW	HP	Output Current (A)	Frame Size
With Filter	Without Filter				
N/A	ODE-3-120023-3012	0.37	0.5	2.3	1
N/A	ODE-3-120043-3012	0.75	1	4.3	1
N/A	ODE-3-120070-3012	1.5	2	7	1
ODE-3-220070-3F42	ODE-3-220070-3042	1.5	2	7	2
ODE-3-220105-3F42	ODE-3-220105-3042	2.2	3	10.5	2
ODE-3-320180-3F42	ODE-3-320180-3042	4.0	5	18	3
ODE-3-320240-3F42	ODE-3-320240-3042	5.5	7.5	24	3
ODE-3-420300-3F42	ODE-3-420300-3042	7.5	10	30	4
ODE-3-420460-3F42	ODE-3-420460-3042	11	15	46	4
ODE-3-520610-3F42	N/A	15	20	61	5
ODE-3-520720-3F42	N/A	18.5	25	72	5

380 - 480V ± 10% - 3 Phase Input - 3 Phase Output					
Model Number		kW	HP	Output Current (A)	Frame Size
With Filter	Without Filter				
ODE-3-140012-3F12	ODE-3-140012-3012	0.37	0.5	1.2	1
ODE-3-140022-3F12	ODE-3-140022-3012	0.75	1	2.2	1
ODE-3-140041-3F12	ODE-3-140041-3012	1.5	2	4.1	1
ODE-3-240041-3F42	ODE-3-240041-3042	1.5	2	4.1	2
ODE-3-240058-3F42	ODE-3-240058-3042	2.2	3	5.8	2
ODE-3-240095-3F42	ODE-3-240095-3042	4	5	9.5	2
ODE-3-340140-3F42	ODE-3-340140-3042	5.5	7.5	14	3
ODE-3-340180-3F42	ODE-3-340180-3042	7.5	10	18	3
ODE-3-340240-3F42	ODE-3-340240-3042	11	15	24	3
ODE-3-440300-3F42	ODE-3-440300-3042	15	20	30	4
ODE-3-440390-3F42	ODE-3-440390-3042	18.5	25	39	4
ODE-3-440460-3F42	ODE-3-440460-3042	22	30	46	4
ODE-3-540610-3F42	N/A	30	40	61	5
ODE-3-540720-3F42	N/A	37	50	72	5

3. Mechanical Installation

3.1. General

- The Optidrive should be mounted in a vertical position only, on a flat, flame resistant, vibration free mounting using the integral mounting holes or DIN Rail clip (Frame Sizes 1 and 2 only).
- IP20 Optidrives are designed to be installed in suitable enclosures to protect them from the environment.
- Do not mount flammable material close to the Optidrive.
- Ensure that the ambient temperature range does not exceed the permissible limits for the Optidrive given in section 9.1. *Environmental on page 36.*
- Provide suitable clean, moisture and contaminant free cooling air sufficient to fulfil the cooling requirements of the Optidrive.

3.2. UL Compliant Installation

Refer to section 9.4. *Additional Information for UL Compliance on page 37* for Additional Information for UL Compliance.

3.3. Mechanical Dimensions and Mounting – IP20 Open Units

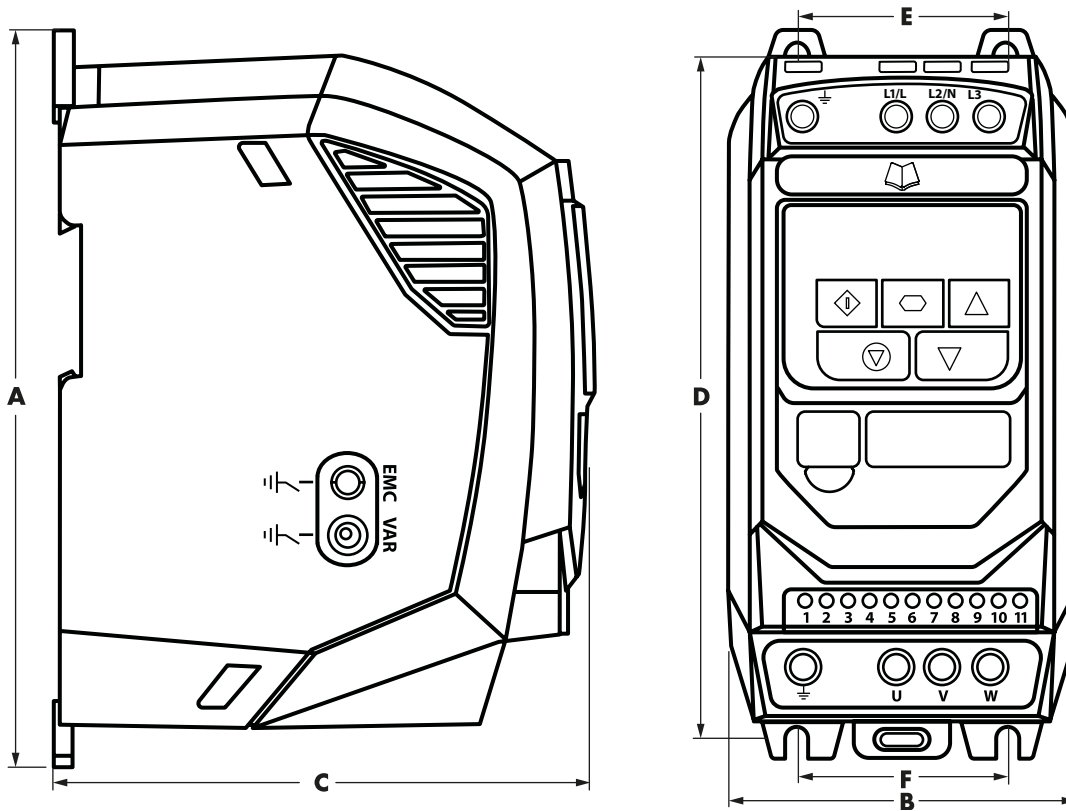

Mechanical Installation

Drive Size	A		B		C		D		E		F		Weight	
	mm	in	mm	in	mm	in	mm	in	mm	in	mm	in	Kg	lb
1	173	6.81	83	3.27	123	4.84	162	6.38	50	1.97	50	1.97	1.0	2.2
2	221	8.70	110	4.33	150	5.91	209	8.23	63	2.48	63	2.48	1.7	3.8
3	261	10.28	131	5.16	175	6.89	247	9.72	80	3.15	80	3.15	3.2	7.1
4	420	16.54	171	6.73	212	8.35	400	15.75	125	4.92	125	4.92	9.1	20.1
5	486	19.13	222	8.74	226	8.89	463	18.22	175	6.88	175	6.88	18.1	39.9

Mounting Bolts		
Frame Size	Metric	UNF
1 - 3	4 x M5	#8
4	4 x M8	#8
5	4 x M8	#8

Tightening Torques			
	Frame Size	Required Torque	Terminal Type
Control Terminals	All	0.5 Nm	4.5 lb-in
	1 - 3	0.8 Nm	7 lb-in
Power Terminals	4	2 Nm	18 lb-in
	5	4 Nm	35.5 lb-in

3.4. Guidelines for Enclosure Mounting

- IP20 drives are designed to be installed in suitable enclosures to protect them from the environment.
- Enclosures should be made from a thermally conductive material.
- Ensure the minimum air gap clearances around the drive as shown below are observed when mounting the drive.
- Where ventilated enclosures are used, there should be venting above the drive and below the drive to ensure good air circulation. Air should be drawn in below the drive and expelled above the drive.
- In any environments where the conditions require it, the enclosure must be designed to protect the Optidrive against ingress of airborne dust, corrosive gases or liquids, conductive contaminants (such as condensation, carbon dust, and metallic particles) and sprays or splashing water from all directions.
- High moisture, salt or chemical content environments should use a suitably sealed (non-vented) enclosure.
- The enclosure design and layout should ensure that the adequate ventilation paths and clearances are left to allow air to circulate through the drive heatsink. Inverter Drives recommend the following minimum sizes for drives mounted in non-ventilated metallic enclosures:

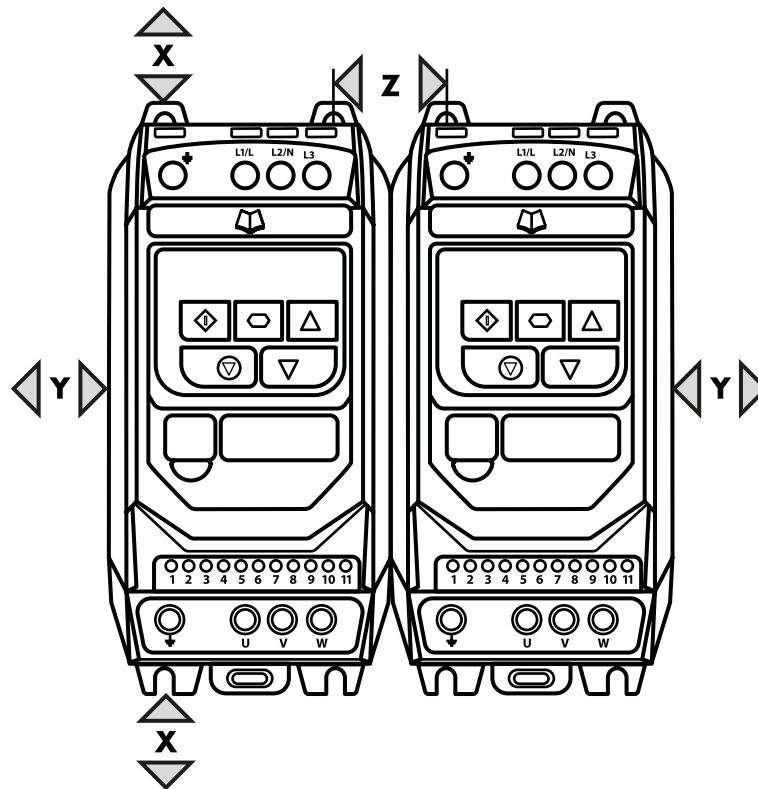

Drive Size	X Above & Below		Y Either Side		Z Between		Recommended airflow CFM (ft ³ /min)
	mm	in	mm	in	mm	in	
1	50	1.97	50	1.97	33	1.30	11
2	75	2.95	50	1.97	46	1.81	22
3	100	3.94	50	1.97	52	2.05	60
4	100	3.94	50	1.97	52	2.05	120
5	200	7.87	25	0.98	70	2.76	104

NOTE

Dimension Z assumes that the drives are mounted side-by-side with no clearance.

Typical drive heat losses are 3% of operating load conditions.

Above are guidelines only and the operating ambient temperature of the drive MUST be maintained at all times.

4. Power & Control Wiring

4.1. Connection Diagram

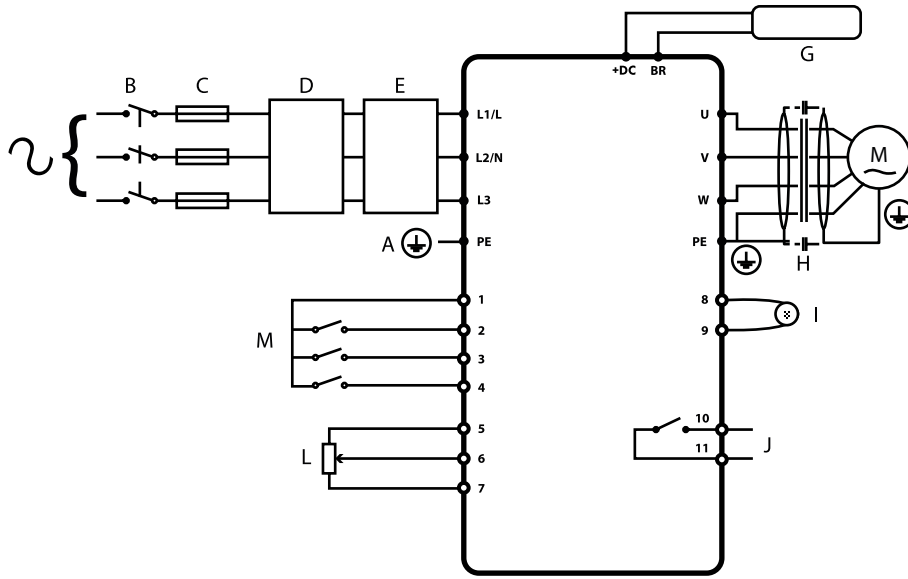

	Key	Sec.	Page
A	Protective Earth (PE) Connection	4.2	11
B	Incoming Power Connection	4.3	12
C	Fuse / Circuit Breaker Selection	4.3.2	12
D	Optional Input Choke	4.3.3	12
E	Optional External EMC Filter	4.10	15
F	Internal Disconnect / Isolator	4.3	12
G	Optional Brake Resistor	4.10	15
H	Motor Connection		
I	Analog Output	4.7.1	13
J	Auxiliary Relay Output	4.7.2	14
L	Analog Inputs	4.7.3	14
M	Digital Inputs	4.7.4	14

4.2. Protective Earth (PE) Connection

Grounding Guidelines

The ground terminal of each Optidrive should be individually connected DIRECTLY to the site ground bus bar (through the filter if installed). Optidrive ground connections should not loop from one drive to another, or to, or from any other equipment. Ground loop impedance must conform to local industrial safety regulations. To meet UL regulations, UL approved ring crimp terminals should be used for all ground wiring connections.

The drive Safety Ground must be connected to system ground. Ground impedance must conform to the requirements of national and local industrial safety regulations and/or electrical codes. The integrity of all ground connections should be checked periodically.

Protective Earth Conductor

The Cross sectional area of the PE Conductor must be at least equal to that of the incoming supply conductor.

Safety Ground

This is the safety ground for the drive that is required by code. One of these points must be connected to adjacent building steel (girder, joist), a floor ground rod, or bus bar. Grounding points must comply with national and local industrial safety regulations and/or electrical codes.

Motor Ground

The motor ground must be connected to one of the ground terminals on the drive.

Ground Fault Monitoring

As with all inverters, a leakage current to earth can exist. The Optidrive is designed to produce the minimum possible leakage current whilst complying with worldwide standards. The level of current is affected by motor cable length and type, the effective switching frequency, the earth connections used and the type of RFI filter installed. If an ELCB (Earth Leakage Circuit Breaker) is to be used, the following conditions apply:

- A Type B Device must be used.
- The device must be suitable for protecting equipment with a DC component in the leakage current.
- Individual ELCBs should be used for each Optidrive.

Shield Termination (Cable Screen)

The safety ground terminal provides a grounding point for the motor cable shield. The motor cable shield connected to this terminal (drive end) should also be connected to the motor frame (motor end). Use a shield terminating or EMI clamp to connect the shield to the safety ground terminal.

4.3. Incoming Power Connection

4.3.1. Cable Selection

- For 1 phase supply, the mains power cables should be connected to L1/L, L2/N.
- For 3 phase supplies, the mains power cables should be connected to L1, L2, and L3. Phase sequence is not important.
- For compliance with CE and C Tick EMC requirements, refer to section 4.9. *EMC Compliant Installation on page 15.*
- A fixed installation is required according to IEC61800-5-1 with a suitable disconnecting device installed between the Optidrive and the AC Power Source. The disconnecting device must conform to the local safety code / regulations (e.g. within Europe, EN60204-1, Safety of machinery).
- The cables should be dimensioned according to any local codes or regulations. Maximum dimensions are given in section 9.2. *Rating Tables on page 36.*

4.3.2. Fuse / Circuit Breaker Selection

- Suitable fuses to provide wiring protection of the input power cable should be installed in the incoming supply line, according to the data in section 9.2. *Rating Tables.* The fuses must comply with any local codes or regulations in place. In general, type gG (IEC 60269) or UL type J fuses are suitable; however in some cases type aR fuses may be required. The operating time of the fuses must be below 0.5 seconds.
- Where allowed by local regulations, suitably dimensioned type B MCB circuit breakers of equivalent rating may be utilised in place of fuses, providing that the clearing capacity is sufficient for the installation.
- The maximum permissible short circuit current at the Optidrive Power terminals as defined in IEC60439-1 is 100kA.

4.3.3. Optional Input Choke

- An optional Input Choke is recommended to be installed in the supply line for drives where any of the following conditions occur:
 - The incoming supply impedance is low or the fault level / short circuit current is high.
 - The supply is prone to dips or brown outs.
 - An imbalance exists on the supply (3 phase drives).
 - The power supply to the drive is via a busbar and brush gear system (typically overhead Cranes).
- In all other installations, an input choke is recommended to ensure protection of the drive against power supply faults. Part numbers are shown in the table.

Supply	Frame Size	AC Input Inductor
230 Volt 1 Phase	1	OPT-2-L1016-20
	2	OPT-2-L1025-20
	3	N/A
400 Volt 3 Phase	1	OPT-2-L3006-20
	2	OPT-2-L3010-20
	3	OPT-2-L3036-20
	4	OPT-2-L3050-20
	5	OPT-2-L3090-20

4.4. Motor Connection

- The drive inherently produces fast switching of the output voltage (PWM) to the motor compared to the mains supply, for motors which have been wound for operation with a variable speed drive then there is no preventative measures required, however if the quality of insulation is unknown then the motor manufacturer should be consulted and preventative measures may be required.
- The motor should be connected to the Optidrive U, V, and W terminals using a suitable 3 or 4 core cable. Where a 3 core cable is utilised, with the shield operating as an earth conductor, the shield must have a cross sectional area at least equal to the phase conductors when they are made from the same material. Where a 4 core cable is utilised, the earth conductor must be of at least equal cross sectional area and manufactured from the same material as the phase conductors.
- The motor earth must be connected to one of the Optidrive earth terminals.
- Maximum permitted motor cable length for all models: 100 metres shielded, 150 metres unshielded.
- Where multiple motors are connected to a single drive using parallel cables, an output choke **must** be installed.

4.5. Motor Terminal Box Connections

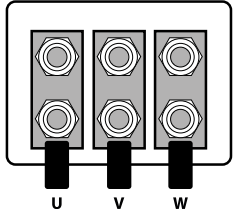
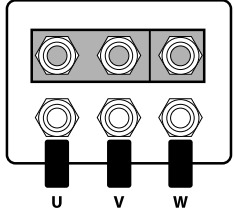

Most general purpose motors are wound for operation on dual voltage supplies. This is indicated on the nameplate of the motor. This operational voltage is normally selected when installing the motor by selecting either STAR or DELTA connection. STAR always gives the higher of the two voltage ratings.

Incoming Supply Voltage	Motor Nameplate Voltages	Connection	
230	230 / 400	Delta Δ	
400	400 / 690		
400	230 / 400	Star λ	

4.6. Control Terminal Wiring

- All analog signal cables should be suitably shielded. Twisted pair cables are recommended.
- Power and Control Signal cables should be routed separately where possible, and must not be routed parallel to each other.
- Signal levels of different voltages e.g. 24 Volt DC and 110 Volt AC, should not be routed in the same cable.
- Maximum control terminal tightening torque is 0.5Nm.
- Control Cable entry conductor size: 0.05 – 2.5mm² / 30 – 12 AWG.

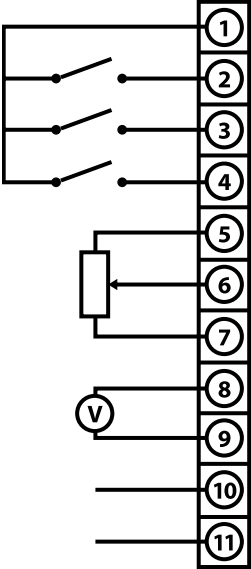
4.7. Control Terminal Connections

Default Connections	Control Terminal	Signal	Description
	1	+24Vdc User Output	+24Vdc user output, 100mA.  Do not connect an external voltage source to this terminal.
	2	Digital Input 1	Positive logic
	3	Digital Input 2	"Logic 1" input voltage range: 8V ... 30V DC "Logic 0" input voltage range: 0V ... 4V DC
	4	Digital Input 3 / Analog Input 2	Digital: 8 to 30V Analog: 0 to 10V, 0 to 20mA or 4 to 20mA
	5	+10V User Output	+10V, 10mA, 1kΩ minimum
	6	Analog Input 1 / Digital Input 4	Analog: 0 to 10V, 0 to 20mA or 4 to 20mA Digital: 8 to 30V
	7	0V	0 Volt Common, internally connected to terminal 9
	8	Analog Output / Digital Output	Analog: 0 to 10V, 20mA maximum Digital: 0 to 24V
	9	0V	0 Volt Common, internally connected to terminal 7
	10	Auxiliary Relay Common	
	11	Auxiliary Relay NO Contact	Contact 250Vac, 6A / 30Vdc, 5A Intended to drive resistive load.

4.7.1. Analog Output

The analog output function may be configured using parameter P-25, which is described in section 6.2. *Extended Parameters on page 20.*

The output has two operating modes, dependent on the parameter selection:

- Analog Mode
 - The output is a 0 – 10 volt DC signal, 20mA max load current.
- Digital Mode
 - The output is 24 volt DC, 20mA max load current.

4.7.2. Relay Output

The relay output function may be configured using parameter P-18, which is described in section 6.2. *Extended Parameters on page 20.*

4.7.3. Analog Inputs

Two analog inputs are available, which may also be used as Digital Inputs if required. The signal formats are selected by parameters as follows:

- Analog Input 1 Format Selection Parameter P-16.
- Analog Input 2 Format Selection Parameter P-47.

These parameters are described more fully in section 6.2. *Extended Parameters on page 20.*

The function of the analog input, e.g. for speed reference or PID feedback for example is defined by parameters P-15. The function of these parameters and available options is described in section 7. *Analog and Digital Input Macro Configurations on page 27.*

4.7.4. Digital Inputs

Up to four digital inputs are available. The function of the inputs is defined by parameters P-12 and P-15, which are explained in section 7. *Analog and Digital Input Macro Configurations on page 27.*

4.8. Motor Thermal Overload Protection

4.8.1. Internal Thermal Overload Protection

Optidrive E3 has internal motor overload protection / current limit set at 150% of FLA. This may be adjusted in parameter P-54. The drive has an in-built motor thermal overload function; this is in the form of an "I.t-trP" trip after delivering >100% of the value set in P-08 for a sustained period of time (e.g. 150% for 60 seconds).

4.8.2. Motor Thermistor Connection

Where a motor thermistor is to be used, it should be connected as follows:

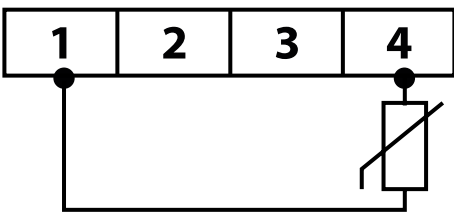
Control Terminal Strip	Additional Information
	<p>Compatible Thermistor: PTC Type, 2.5kΩ trip level.</p> <ul style="list-style-type: none"> ▪ Use a setting of P-15 that has Input 3 function as External Trip, e.g. P-15 = 3. Refer to section 7. <i>Analog and Digital Input Macro Configurations on page 27</i> for further details. ▪ Set P-47 = "Ptc-Th"

4.9. EMC Compliant Installation

Category	Supply Cable Type	Motor Cable Type	Control Cables	Maximum Permissible Motor Cable Length
C1 ⁶	Shielded ¹	Shielded ^{1,5}	Shielded ⁴	1M / 5M ⁷
C2	Shielded ²	Shielded ^{1,5}		5M / 25M ⁷
C3	Unshielded ³	Shielded ²		25M / 100M ⁷

- ¹ A screened (shielded) cable suitable for fixed installation with the relevant mains voltage in use. Braided or twisted type screened cable where the screen covers at least 85% of the cable surface area, designed with low impedance to HF signals. Installation of a standard cable within a suitable steel or copper tube is also acceptable.
- ² A cable suitable for fixed installation with relevant mains voltage with a concentric protection wire. Installation of a standard cable within a suitable steel or copper tube is also acceptable.
- ³ A cable suitable for fixed installation with relevant mains voltage. A shielded type cable is not necessary.
- ⁴ A shielded cable with low impedance shield. Twisted pair cable is recommended for analog signals.
- ⁵ The cable screen should be terminated at the motor end using an EMC type gland allowing connection to the motor body through the largest possible surface area. Where drives are mounted in a steel control panel enclosure, the cable screen may be terminated directly to the control panel using a suitable EMC clamp or gland, as close to the drive as possible.
- ⁶ Compliance with category C1 conducted emissions only is achieved. For compliance with category C1 radiated emissions, additional measures may be required, contact your Sales Partner for further assistance.
- ⁷ Permissible cable length with additional external EMC filter.

4.10. Optional Brake Resistor

Optidrive E3 Frame Size 2 and above units have a built in Brake Transistor. This allows an external resistor to be connected to the drive to provide improved braking torque in applications that require this.

The brake resistor should be connected to the “+” and “BR” terminals as shown.



The voltage level at these terminals may exceed 800VDC.
 Stored charge may be present after disconnecting the mains power.
 Allow a minimum of 10 minutes discharge after power off before attempting any connection to these terminals.

Suitable resistors and guidance on selection can be obtained from your Invertek Sales Partner.

Dynamic Brake Transistor with Thermal Overload Protection

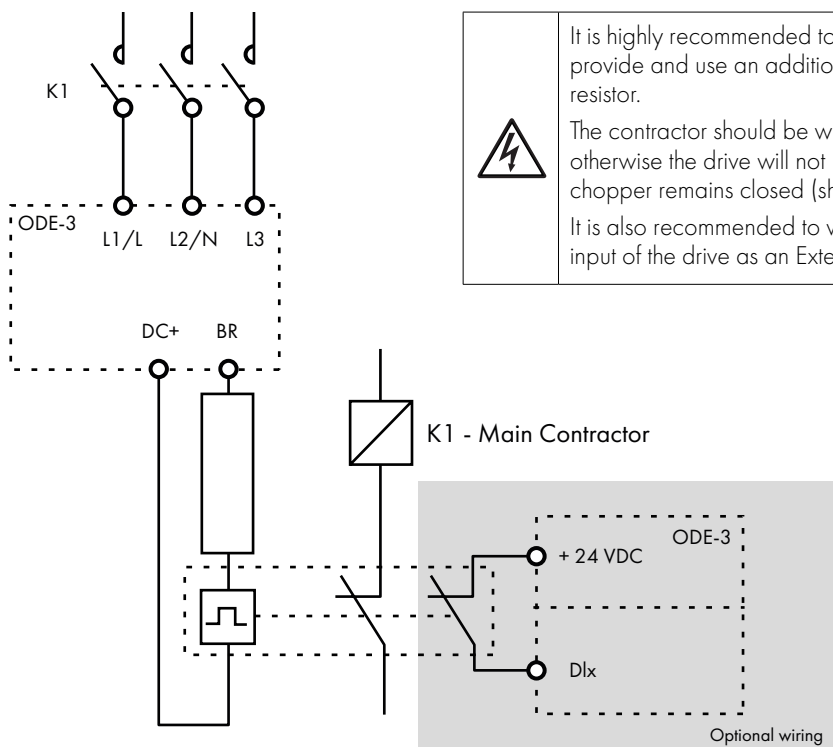

It is highly recommended to equip the drive with a main contractor and provide and use an additional thermal overload protection for braking resistor.
 The contractor should be wired so that it opens in case the resistor overheats, otherwise the drive will not be able to interrupt the main supply if the brake chopper remains closed (short-circuited) in a faulty situation.
 It is also recommended to wire the thermal overload protection to a digital input of the drive as an External Trip.







The voltage level at these terminals may exceed 800VDC.
 Stored charge may be present after disconnecting the mains power.
 Allow a minimum of 5 minutes discharge after power off before attempting any connection to these terminals.

Thermal Overload / Brake Resistor with internal Over Temperature switch

5. Operation

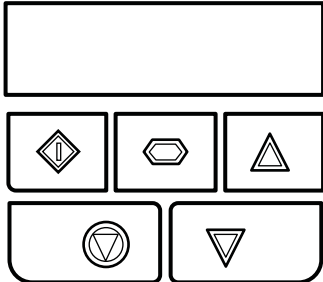
5.1. Managing the Keypad

The drive is configured and its operation monitored via the keypad and display.

	NAVIGATE	Used to display real-time information, to access and exit parameter edit mode and to store parameter changes.	
	UP	Used to increase speed in real-time mode or to increase parameter values in parameter edit mode.	
	DOWN	Used to decrease speed in real-time mode or to decrease parameter values in parameter edit mode.	
	RESET / STOP	Used to reset a tripped drive. When in Keypad mode is used to Stop a running drive.	
	START	When in keypad mode, used to Start a stopped drive or to reverse the direction of rotation if bi-directional keypad mode is enabled.	

5.2. Operating Displays

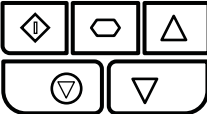
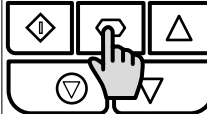
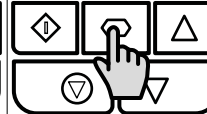
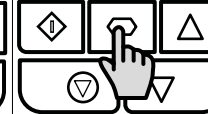
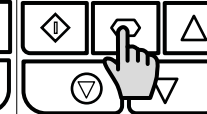
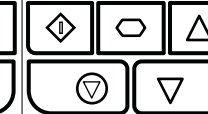
<i>Stop</i>	<i>H 50.0</i>	<i>A 2.3</i>	<i>P 1.50</i>	<i>1500</i>	<i>FirE</i>
					
Drive Stopped / Disabled	Drive is enabled / running, display shows the output frequency (Hz)	Press the Navigate key for < 1 second. The display will show the motor current (Amps)	Press the Navigate key for < 1 second. The display will show the motor power (kW)	If P-10 > 0, pressing the Navigate key for < 1 second will display the motor speed (RPM)	Drive is in fire mode and can't be reset until fire mode is deactivated

5.3. Changing Parameters

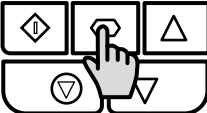
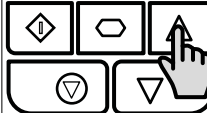
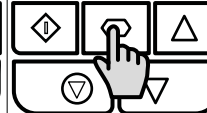
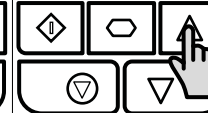
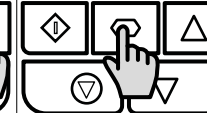
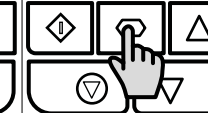
<i>Stop</i>	<i>P-01</i>	<i>P-08</i>	<i>10</i>	<i>P-08</i>	<i>P-08</i>
					
Press and hold the Navigate key > 2 seconds	Use the up and down keys to select the required parameter	Press the Navigate key for < 1 second	Adjust the value using the Up and Down keys	Press for < 1 second to return to the parameter menu	Press for > 2 seconds to return to the operating display

5.4. Read Only Parameter Access

StoP	P-00	P00-01	P00-08	330	StoP
Press and hold the Navigate key > 2 seconds	Use the up and down keys to select P-00	Press the Navigate key for < 1 second	Use the up and down keys to select the required Read Only parameter	Press the Navigate key for < 1 second to display the value	Press and hold the Navigate key > 2 seconds to return to the operating display

5.5. Resetting Parameters

P-dEF	StoP
To reset parameter values to their factory default settings, press and hold Up, Down and Stop buttons for > 2 seconds. The display will show "P-dEF"	Press the Stop key. The display will show "StoP"

5.6. Resetting a Fault

0-1	StoP
Press the Stop key. The display will show "StoP"	

5.7. LED Display

Optidrive E3 has a built-in 6 Digit 7 Segment LED Display. In order to display certain warnings, the following methods are used:

5.7.1 LED Display Layout



5.7.2 LED Display Meanings

LED Segments	Behaviour	Meaning
a, b, c, d, e, f	Flashing all together	Overload, motor output current exceeds P-08
a and f	Flashing alternately	Mains Loss (Incoming AC power has been removed)
a	Flashing	Fire Mode Active

6. Parameters

6.1. Standard Parameters

Par.	Description	Minimum	Maximum	Default	Units
P-01	Maximum Frequency / Speed Limit	P-02	500.0	50.0 (60.0)	Hz / RPM
	Maximum output frequency or motor speed limit – Hz or RPM. If P-10 >0, the value entered / displayed is in RPM.				
P-02	Minimum Frequency / Speed Limit	0.0	P-01	0.0	Hz / RPM
	Minimum speed limit – Hz or RPM. If P-10 >0, the value entered / displayed is in RPM.				
P-03	Acceleration Ramp Time	0.00	600.0	5.0	s
	Acceleration ramp time from zero Hz / RPM to base frequency (P-09) in seconds.				
P-04	Deceleration Ramp Time	0.00	600.0	5.0	s
	Deceleration ramp time from base frequency (P-09) to standstill in seconds. When set to 0.00, the value of P-24 is used.				
P-05	Stopping Mode / Mains Loss Response	0	4	0	-
	Selects the stopping mode of the drive, and the behaviour in response to a loss of mains power supply during operation.				
	Setting	On Disable	On Mains Loss		
	0	Ramp to Stop (P-04)	Ride Through (Recover energy from load to maintain operation)		
	1	Coast	Coast		
	2	Ramp to Stop (P-04)	Fast Ramp to Stop (P-24), Coast if P-24 = 0		
	3	Ramp to Stop (P-04) with AC Flux Braking	Fast Ramp to Stop (P-24), Coast if P-24 = 0		
4	Ramp to Stop (P-04)	No action			
P-06	Energy Optimiser	0	3	0	-
	Motor Energy Optimisation is intended for use in applications where the motor operates for extended time periods at constant speed with light load. It should not be used in applications with large, sudden step changes in load or for PI control applications.				
	Optidrive Energy Optimisation reduces the drive internal heat losses increasing efficiency however it may result in some vibration in the motor during light load operation. In general, this function is suited to Fan, Pump and Compressor applications.				
	Setting	Motor Energy Optimisation	Optidrive Energy Optimisation		
	0	Disabled	Disabled		
	1	Enabled	Disabled		
	2	Disabled	Enabled		
3	Enabled	Enabled			
P-07	Motor Rated Voltage / Back EMF at rated speed (PM / BLDC)	0	250 / 500	230 / 400	V
	For Induction Motors, this parameter should be set to the rated (nameplate) voltage of the motor (Volts). For Permanent Magnet or Brushless DC Motors, it should be set to the Back EMF at rated speed.				
P-08	Motor Rated Current	Drive Rating Dependent			A
	This parameter should be set to the rated (nameplate) current of the motor.				
P-09	Motor Rated Frequency	10	500	50 (60)	Hz
	This parameter should be set to the rated (nameplate) frequency of the motor.				
P-10	Motor Rated Speed	0	30000	0	RPM
	This parameter can optionally be set to the rated (nameplate) RPM of the motor. When set to the default value of zero, all speed related parameters are displayed in Hz and the slip compensation (where motor speed is maintained at a constant value regardless of applied load) for the motor is disabled. Entering the value from the motor nameplate enables the slip compensation function, and the Optidrive display will now show motor speed in RPM. All speed related parameters, such as Minimum and Maximum Speed, Preset Speeds etc. will also be displayed in RPM. NOTE If P-09 value is changed, P-10 value is reset to 0.				

Par.	Description	Minimum	Maximum	Default	Units																							
P-11	Low Frequency Torque Boost	0.0	Drive Dependent	Drive Dependent	%																							
	<p>Low frequency torque can be improved by increasing this parameter. Excessive boost levels may however result in high motor current and increased risk of tripping on Over Current or Motor Overload (refer to section 10.1. <i>Fault Code Messages on page 39</i>).</p> <p>This parameter operates in conjunction with P-51 (Motor Control Mode) as follows:</p> <table border="1"> <thead> <tr> <th>P-51</th> <th>P-11</th> <th></th> </tr> </thead> <tbody> <tr> <td rowspan="2">0</td> <td>0</td> <td>Boost is automatically calculated according to autotune data.</td> </tr> <tr> <td>>0</td> <td>Voltage boost = P-11 x P-07. This voltage is applied at 0.0Hz, and linearly reduced until P-09 / 2.</td> </tr> <tr> <td>1</td> <td>All</td> <td>Voltage boost = P-11 x P-07. This voltage is applied at 0.0Hz, and linearly reduced until P-09 / 2.</td> </tr> <tr> <td>2, 3, 4, 5</td> <td>All</td> <td>Boost current level = 4 * P-11 * P-08.</td> </tr> </tbody> </table> <p>For IM motors, when P-51 = 0 or 1, a suitable setting can usually be found by operating the motor under very low or no load conditions at approximately 5Hz, and adjusting P-11 until the motor current is approximately the magnetising current (if known) or in the range shown below.</p> <p>Frame Size 1: 60 – 80% of motor rated current. Frame Size 2: 50 – 60% of motor rated current. Frame Size 3: 40 – 50% of motor rated current. Frame Size 4 & 5: 35 – 45% of motor rated current.</p>					P-51	P-11		0	0	Boost is automatically calculated according to autotune data.	>0	Voltage boost = P-11 x P-07. This voltage is applied at 0.0Hz, and linearly reduced until P-09 / 2.	1	All	Voltage boost = P-11 x P-07. This voltage is applied at 0.0Hz, and linearly reduced until P-09 / 2.	2, 3, 4, 5	All	Boost current level = 4 * P-11 * P-08.									
P-51	P-11																											
0	0	Boost is automatically calculated according to autotune data.																										
	>0	Voltage boost = P-11 x P-07. This voltage is applied at 0.0Hz, and linearly reduced until P-09 / 2.																										
1	All	Voltage boost = P-11 x P-07. This voltage is applied at 0.0Hz, and linearly reduced until P-09 / 2.																										
2, 3, 4, 5	All	Boost current level = 4 * P-11 * P-08.																										
P-12	Primary Command Source	0	9	0	-																							
	<p>0: Terminal Control. The drive responds directly to signals applied to the control terminals.</p> <p>1: Uni-directional Keypad Control. The drive can be controlled in the forward direction only using the internal keypad, or an external remote Keypad.</p> <p>2: Bi-directional Keypad Control. The drive can be controlled in the forward and reverse directions using the internal keypad, or an external remote Keypad. Pressing the keypad START button toggles between forward and reverse.</p> <p>3: Modbus Network Control. Control via Modbus RTU (RS485) using the internal Accel / Decel ramps.</p> <p>4: Modbus Network Control. Control via Modbus RTU (RS485) interface with Accel / Decel ramps updated via Modbus.</p> <p>5: PI Control. User PI control with external feedback signal.</p> <p>6: PI Analog Summation Control. PI control with external feedback signal and summation with analog input 1.</p> <p>7: CAN Control. Control via CAN (RS485) using the internal Accel / Decel ramps.</p> <p>8: CAN Control. Control via CAN (RS485) interface with Accel / Decel ramps updated via CAN.</p> <p>9: Slave Mode. Control via a connected Invertek drive in Master Mode. Slave drive address must be > 1.</p> <p>NOTE When P-12 = 1, 2, 3, 4, 7, 8 or 9, an enable signal must still be provided at the control terminals, digital input 1.</p>																											
P-13	Operating Mode Select	0	2	0	-																							
	<p>Provides a quick set up to configure key parameters according to the intended application of the drive. Parameters are preset according to the table.</p> <p>0: Industrial Mode. Intended for general purpose applications.</p> <p>1: Pump Mode. Intended for centrifugal pump applications.</p> <p>2: Fan Mode. Intended for Fan applications.</p> <table border="1"> <thead> <tr> <th>Setting</th> <th>Application</th> <th>Current Limit (P-54)</th> <th>Torque Characteristic</th> <th>Spin Start (P-33)</th> <th>Thermal Overload Limit Reaction (P-60 Index 2)</th> </tr> </thead> <tbody> <tr> <td>0</td> <td>General</td> <td>150%</td> <td>Constant</td> <td>0: Off</td> <td>0: Trip</td> </tr> <tr> <td>1</td> <td>Pump</td> <td>110%</td> <td>Variable</td> <td>0: Off</td> <td>1: Current Limit Reduction</td> </tr> <tr> <td>2</td> <td>Fan</td> <td>110%</td> <td>Variable</td> <td>2: On</td> <td>1: Current Limit Reduction</td> </tr> </tbody> </table>					Setting	Application	Current Limit (P-54)	Torque Characteristic	Spin Start (P-33)	Thermal Overload Limit Reaction (P-60 Index 2)	0	General	150%	Constant	0: Off	0: Trip	1	Pump	110%	Variable	0: Off	1: Current Limit Reduction	2	Fan	110%	Variable	2: On
Setting	Application	Current Limit (P-54)	Torque Characteristic	Spin Start (P-33)	Thermal Overload Limit Reaction (P-60 Index 2)																							
0	General	150%	Constant	0: Off	0: Trip																							
1	Pump	110%	Variable	0: Off	1: Current Limit Reduction																							
2	Fan	110%	Variable	2: On	1: Current Limit Reduction																							
P-14	Extended Menu Access code	0	65535	0	-																							
	<p>Enables access to Extended and Advanced Parameter Groups. This parameter must be set to the value programmed in P-37 (default: 101) to view and adjust Extended Parameters and value of P-37 + 100 to view and adjust Advanced Parameters. The code may be changed by the user in P-37 if desired.</p>																											

6.2. Extended Parameters

Par.	Description	Minimum	Maximum	Default	Units
P-15	Digital Input Function Select Defines the function of the digital inputs depending on the control mode setting in P-12. See section 7. <i>Analog and Digital Input Macro Configurations</i> on page 27 for more information.	0	19	0	-
P-16	Analog Input 1 Signal Format U 0-10 = Uni-polar 0 to 10 Volt Signal. The drive will remain at minimum speed (P-02) if the analog reference after scaling and offset are applied is $\leq 0.0\%$. 100% signal means the output frequency / speed will be the value set in P-01. b 0-10 = Uni-polar 0 to 10 Volt Signal, bi-directional operation. The drive will operate the motor in the reverse direction of rotation if the analog reference after scaling and offset are applied is $< 0.0\%$. e.g. for bidirectional control from a 0 – 10 volt signal, set P-35 = 200.0%, P-39 = 50.0%. A 0-20 = 0 to 20mA Signal. E 4-20 = 4 to 20mA Signal, the Optidrive will trip and show the fault code 4-20F 500ms after the signal level falls below 3mA. r 4-20 = 4 to 20mA Signal, the Optidrive will run at Preset Speed 1 (P-20 if the signal level falls below 3mA). E 20-4 = 20 to 4mA Signal, the Optidrive will trip and show the fault code 4-20F 500ms after the signal level falls below 3mA. r 20-4 = 20 to 4mA Signal, the Optidrive will run at Preset Speed 1 (P-20 if the signal level falls below 3mA). U 10-0 = 10 to 0 Volt Signal (Uni-polar). The drive will operate at Maximum Frequency / Speed if the analog reference after scaling and offset are applied is $\leq 0.0\%$.	See Below		U0-10	-
P-17	Maximum Effective Switching Frequency Sets maximum effective switching frequency of the drive. If "rEd" is displayed when the parameter is viewed, the switching frequency has been reduced to the level in P00-32 due to excessive drive heatsink temperature.	4	32	8	kHz
P-18	Output Relay Function Select Selects the function assigned to the relay output. The relay has two output terminals, Logic 1 indicates the relay is active, and therefore terminals 10 and 11 will be connected. 0: Drive Enabled (Running). Logic 1 when the motor is enabled. 1: Drive Healthy. Logic 1 when power is applied to the drive and no fault exists. 2: At Target Frequency (Speed). Logic 1 when the output frequency matches the setpoint frequency. 3: Drive Tripped. Logic 1 when the drive is in a fault condition. 4: Output Frequency \geq Limit. Logic 1 when the output frequency exceeds the adjustable limit set in P-19. 5: Output Current \geq Limit. Logic 1 when the motor current exceeds the adjustable limit set in P-19. 6: Output Frequency $<$ Limit. Logic 1 when the output frequency is below the adjustable limit set in P-19. 7: Output Current $<$ Limit. Logic 1 when the motor current is below the adjustable limit set in P-19. 8: Analog Input 2 $>$ Limit. Logic 1 when the signal applied to analog input 2 exceeds the adjustable limit set in P-19. 9: Drive Ready to Run. Logic 1 when the drive is ready to run, no trip present. 10: Fire Mode Active. Logic 1 when Fire Mode is activated. 11: Output Frequency $>$ Limit and not Fire Mode. As setting 4 however the output relay state does not change if the drive is in Fire Mode. 12: Fieldbus. Status is controlled by bit 8 of the fieldbus control word. Fieldbus type is selected by P-12.	0	12	1	-
P-19	Relay Threshold Level Adjustable threshold used in conjunction with settings 4 to 7 of P-18 and P-25.	0.0	200.0	100.0	%
P-20	Preset Frequency / Speed 1	-P-01	P-01	5.0	Hz / RPM
P-21	Preset Frequency / Speed 2	-P-01	P-01	25.0	Hz / RPM
P-22	Preset Frequency / Speed 3	-P-01	P-01	40.0	Hz / RPM
P-23	Preset Frequency / Speed 4 Preset Speeds / Frequencies selected by digital inputs depending on the setting of P-15. If P-10 = 0, the values are entered as Hz. If P-10 > 0, the values are entered as RPM. NOTE Changing the value of P-09 will reset all values to factory default settings.	-P-01	P-01	P-09	Hz / RPM
P-24	2nd Ramp Time (Fast Stop) This parameter allows a 2nd ramp time to be programmed into the drive. This ramp time is automatically selected in the case of a mains power loss if P-05 = 2 or 3. When set to 0.00, the drive will coast to stop. When using a setting of P-15 that provides a "Fast Stop" function, this ramp time is also used. In addition, if P-24 > 0, P-02 > 0, P-26=0 and P-27 = P-02, this ramp time is applied to both acceleration and deceleration when operating below minimum speed, allowing selection of an alternative ramp when operating outside of the normal speed range, which may be useful in pump and compressor applications.	0.00	600.0	0.00	s

Par.	Description	Minimum	Maximum	Default	Units
P-25	Analog Output Function Select	0	12	8	-
	<p>Digital Output Mode. Logic 1 = +24V DC</p> <p>0: Drive Enabled (Running). Logic 1 when the Optidrive is enabled (Running).</p> <p>1: Drive Healthy. Logic 1 When no Fault condition exists on the drive.</p> <p>2: At Target Frequency (Speed). Logic 1 when the output frequency matches the setpoint frequency.</p> <p>3: Drive Tripped. Logic 1 when the drive is in a fault condition.</p> <p>4: Output Frequency >= Limit. Logic 1 when the output frequency exceeds the adjustable limit set in P-19.</p> <p>5: Output Current >= Limit. Logic 1 when the motor current exceeds the adjustable limit set in P-19.</p> <p>6: Output Frequency < Limit. Logic 1 when the output frequency is below the adjustable limit set in P-19.</p> <p>7: Output Current < Limit. Logic 1 when the motor current is below the adjustable limit set in P-19.</p> <p>Analog Output Mode</p> <p>8: Output Frequency (Motor Speed). 0 to P-01, resolution 0.1Hz.</p> <p>9: Output (Motor) Current. 0 to 200% of P-08, resolution 0.1A.</p> <p>10: Output Power. 0 – 200% of drive rated power.</p> <p>11: Load Current. 0 – 200% of P-08, resolution 0.1A.</p> <p>12: Fieldbus Digital. Status is controlled by PDO0 Bit 9.</p> <p>13: Fieldbus Analog. Analog output value set by PDO2 value, 0 – 4096.</p>				
P-26	Skip Frequency Hysteresis Band	0.0	P-01	0.0	Hz / RPM
P-27	Skip Frequency Centre Point	0.0	P-01	0.0	Hz / RPM
<p>The Skip Frequency function is used to avoid the Optidrive operating at a certain output frequency, for example at a frequency which causes mechanical resonance in a particular machine. Parameter P-27 defines the centre point of the skip frequency band, and is used in conjunction with P-26. The Optidrive output frequency will ramp through the defined band at the rates set in P-03 and P-04 respectively, and will not hold any output frequency within the defined band. If the frequency reference applied to the drive is within the band, the Optidrive output frequency will remain at the upper or lower limit of the band.</p>					
P-28	V/F Characteristic Adjustment Voltage	0	P-07	0	V
P-29	V/F Characteristic Adjustment Voltage	0.0	P-09	0.0	Hz
<p>This parameter in conjunction with P-28 sets a frequency point at which the voltage set in P-29 is applied to the motor. Care must be taken to avoid overheating and damaging the motor when using this feature.</p>					
P-30	Start Mode, Automatic Restart, Fire Mode Operation				
	Index 1: Start Mode & Automatic Restart	N/A	N/A	Edge-r	-
	<p>Selects whether the drive should start automatically if the enable input is present and latched during power on. Also configures the Automatic Restart function.</p> <p>Edge-r: Following Power on or reset, the drive will not start if Digital Input 1 remains closed. The Input must be closed after a power on or reset to start the drive.</p> <p>Auto-0: Following a Power On or Reset, the drive will automatically start if Digital Input 1 is closed.</p> <p>Auto-1 To Auto-5: Following a trip, the drive will make up to 5 attempts to restart at 20 second intervals. The numbers of restart attempts are counted, and if the drive fails to start on the final attempt, the drive will trip with a fault, and will require the user to manually reset the fault. The drive must be powered down to reset the counter.</p>				
	Index 2: Fire Mode Input Logic	0	3	0	-
	<p>Defines the operating logic when a setting of P-15 is used which includes Fire Mode, e.g. settings 15, 16 & 17.</p> <p>0: n.C: Normally Closed (NC) Input. Fire Mode active if input is open.</p> <p>1: n.O: Normally Open (NO) Input. Fire Mode active if input is closed.</p> <p>2: F-N.C: Normally Closed (NC) Input, Fixed Speed. Fire Mode active if input is open. Fire Mode Speed is Preset Speed 4 (P-23).</p> <p>3: F-N.O: Normally Open (NO) Input, Fixed Speed. Fire Mode active if input is closed. . Fire Mode Speed is Preset Speed 4 (P-23).</p>				
Index 3: Fire Mode Input Type	0	1	0	-	
<p>Defines the input type when a setting of P-15 is used which includes Fire Mode, e.g. settings 15, 16 & 17.</p> <p>0: Off. The drive will remain in Fire Mode, only as long the fire mode input signal remains (Normally Open or Normally Closed operation is supported depending on Index 2 setting).</p> <p>1: On. Fire Mode is activated by a momentary signal on the input. Normally Open or Normally Closed operation is supported depending on Index 2 setting. The drive will remain in Fire Mode until disabled or powered off.</p>					

Par.	Description	Minimum	Maximum	Default	Units
P-31	Keypad Start Mode Select	0	7	1	-
	<p>This parameter is active only when operating in Keypad Control Mode (P-12 = 1 or 2) or Modbus Mode (P-12 = 3 or 4). When settings 0, 1, 4 or 5 are used, the Keypad Start and Stop keys are active, and control terminals 1 and 2 must be linked together. Settings 2, 3, 6 and 7 allow the drive to be started from the control terminals directly, and the keypad Start and Stop keys are ignored.</p> <p>0: Minimum Speed, Keypad Start 1: Previous Speed, Keypad Start 2: Minimum Speed, Terminal Enable 3: Previous Speed, Terminal Enable 4: Current Speed, Keypad Start 5: Preset Speed 4, Keypad Start 6: Current Speed, Terminal Start 7: Preset Speed 4, Terminal Start</p>				
P-32	DC Injection Configuration				
	Index 1: Duration	0.0	25.0	0.0	s
	Index 2: DC Injection Mode	0	2	0	-
	<p>Index 1: Defines the time for which a DC current is injected into the motor. DC Injection current level may be adjusted in P-59.</p> <p>Index 2: Configures the DC Injection Function as follows:</p> <p>0: DC Injection on Stop. DC is injected into the motor at the current level set in P-59 following a stop command, after the output frequency has reduced to P-58 for the time set in Index 1.</p> <p>NOTE If the drive is in Standby Mode prior to disable, the DC injection is disabled</p> <p>1: DC Injection on Start. DC is injected into the motor at the current level set in P-59 for the time set in Index 1 immediately after the drive is enabled, prior to the output frequency ramping up. The output stage remains active during this phase. This can be used to ensure the motor is at standstill prior to starting.</p> <p>2: DC Injection on Start & Stop. DC injection applied as both settings 0 and 1 above.</p>				
P-33	Spin Start	0	2	0	-
	<p>0: Disabled</p> <p>1: Enabled. When enabled, on start up the drive will attempt to determine if the motor is already rotating, and will begin to control the motor from its current speed. A short delay may be observed when starting motors which are not turning.</p> <p>2: Enabled on Trip, Brown Out or Coast Stop. Spin start is only activated following the events listed, otherwise it is disabled.</p>				
P-34	Brake Chopper Enable (Not Size 1)	0	4	0	-
	<p>0: Disabled</p> <p>1: Enabled With Software Protection. Brake chopper enabled with software protection for a 200W continuous rated resistor.</p> <p>2: Enabled Without Software Protection. Enables the internal brake chopper without software protection. An external thermal protection device should be fitted.</p> <p>3: Enabled With Software Protection. As setting 1, however the Brake Chopper is only enabled during a change of the frequency setpoint, and is disabled during constant speed operation.</p> <p>4: Enabled Without Software Protection. As setting 2, however the Brake Chopper is only enabled during a change of the frequency setpoint, and is disabled during constant speed operation.</p>				
P-35	Analog Input 1 Scaling / Slave Speed Scaling	0.0	2000.0	100.0	%
	<p>Analog Input 1 Scaling. The analog input signal level is multiplied by this factor, e.g. if P-16 is set for a 0 – 10V signal, and the scaling factor is set to 200.0%, a 5 volt input will result in the drive running at maximum frequency / speed (P-01).</p> <p>Slave Speed Scaling. When operating in Slave Mode (P-12 = 9), the operating speed of the drive will be the Master speed multiplied by this factor, limited by the minimum and maximum speeds.</p>				

Par.	Description	Minimum	Maximum	Default	Units	
P-36	Serial Communications Configuration	See Below				
	Index 1: Address	0	63	1	-	
	Index 2: Baud Rate	9.6	1000	115.2	kbps	
	Index 3: Communication loss protection	0	3000	† 3000	ms	
	This parameter has three sub settings used to configure the Modbus RTU Serial Communications. The Sub Parameters are:					
	<p>1st Index: Drive Address: Range: 0 – 63, default: 1.</p> <p>2nd Index: Baud Rate & Network type: Selects the baud rate and network type for the internal RS485 communication port. For Modbus RTU: Baud rates 9.6, 19.2, 38.4, 57.6, 115.2 kbps are available. For CAN: Baud rates 125, 250, 500 & 1000 kbps are available.</p> <p>3rd Index: Watchdog Timeout: Defines the time for which the drive will operate without receiving a valid command telegram after the drive has been enabled. This applies to Modbus RTU networks and Optibus networks (e.g. keypad control or Master Slave operation) only. CAN communication loss function is enabled via CAN objects 100Ch and 100Dh. Setting 0 disables the Watchdog timer. Setting a value of 30, 100, 1000, or 3000 defines the time limit in milliseconds for operation. A ‘t’ suffix selects trip on loss of communication. An ‘r’ suffix means that the drive will coast stop (output immediately disabled) but will not trip.</p>					
P-37	Access Code Definition	0	9999	101	-	
Defines the access code which must be entered in P-14 to access parameters above P-14.						
P-38	Parameter Access Lock	0	1	0	-	
	<p>0: Unlocked. All parameters can be accessed and changed.</p> <p>1: Locked. Parameter values can be displayed, but cannot be changed except P-38.</p>					
P-39	Analog Input 1 Offset	-500.0	500.0	0.0	%	
	<p>Sets an offset, as a percentage of the full scale range of the input, which is applied to the analog input signal. This parameter operates in conjunction with P-35, and the resultant value can be displayed in P00-01.</p> <p>The resultant value is defined as a percentage, according to the following: $P00-01 = (\text{Applied Signal Level}(\%) - P-39) \times P-35$.</p>					
P-40	Index 1: Display Scaling Factor	0.000	16.000	0.000	-	
	Index 2: Display Scaling Source	0	3	0	-	
	Allows the user to program the Optidrive to display an alternative output unit scaled from either output frequency (Hz), Motor Speed (RPM) or the signal level of PI feedback when operating in PI Mode.					
	<p>Index 1: Used to set the scaling multiplier. The chosen source value is multiplied by this factor.</p> <p>Index 2: Defines the scaling source as follows: 0: Motor Speed. Scaling is applied to the output frequency if P-10 = 0, or motor RPM if P-10 > 0. 1: Motor Current. Scaling is applied to the motor current value (Amps). 2: Analog Input 2 Signal Level. Scaling is applied to analog input 2 signal level, internally represented as 0 – 100.0%. 3: PI Feedback. Scaling is applied to the PI feedback selected by P-46, internally represented as 0 – 100.0%.</p>					
P-41	PI Controller Proportional Gain	0.0	30.0	1.0	-	
	PI Controller Proportional Gain. Higher values provide a greater change in the drive output frequency in response to small changes in the feedback signal. Too high a value can cause instability.					
P-42	PI Controller Integral Time	0.0	30.0	1.0	s	
	PI Controller Integral Time. Larger values provide a more damped response for systems where the overall process responds slowly.					
P-43	PI Controller Operating Mode	0	3	0	-	
	<p>0: Direct Operation. Use this mode if when the feedback signal drops, the motor speed should increase.</p> <p>1: Inverse Operation. Use this mode if when the feedback signal drops, the motor speed should decrease.</p> <p>2: Direct Operation, Wake at Full Speed. As setting 0, but on restart from Standby, PI Output is set to 100%.</p> <p>3: Inverse Operation, Wake at Full Speed. As setting 0, but on restart from Standby, PI Output is set to 100%.</p>					
P-44	PI Reference (Setpoint) Source Select	0	1	0	-	
	Selects the source for the PID Reference / Setpoint.					
	<p>0: Digital Preset Setpoint. P-45 is used.</p> <p>1: Analog Input 1 Setpoint. Analog input 1 signal level, readable in P00-01 is used for the setpoint.</p> <p>2: Fieldbus. The setpoint is determined by fieldbus PDO2 (Modbus RTU register 3) value.</p>					

Par.	Description	Minimum	Maximum	Default	Units
P-45	PI Digital Setpoint	0.0	100.0	0.0	%
	When P-44 = 0, this parameter sets the preset digital reference (setpoint) used for the PI Controller as a % of the feedback signal.				
P-46	PI Feedback Source Select	0	5	0	-
	<p>Selects the source of the feedback signal to be used by the PI controller.</p> <p>0: Analog Input 2 (Terminal 4) Signal level readable in P00-02.</p> <p>1: Analog Input 1 (Terminal 6) Signal level readable in P00-01.</p> <p>2: Motor Current Scaled as % of P-08.</p> <p>3: DC Bus Voltage Scaled 0 – 1000 Volts = 0 – 100%.</p> <p>4: Analog 1 – Analog 2 The value of Analog Input 2 is subtracted from Analog 1 to give a differential signal. The value is limited to 0.</p> <p>5: Largest (Analog 1, Analog 2) The larger of the two analog input values is always used for PI feedback.</p>				
P-47	Analog Input 2 Signal Format	-	-	-	U0-10
	<p>U 0-10 = 0 to 10 Volt Signal.</p> <p>A 0-20 = 0 to 20mA Signal.</p> <p>E 4-20 = 4 to 20mA Signal, the Optidrive will trip and show the fault code 4-20F 500ms after the signal level falls below 3mA.</p> <p>r 4-20 = 4 to 20mA Signal, the Optidrive will run at Preset Speed 1 (P-20) if the signal level falls below 3mA.</p> <p>E 20-4 = 20 to 4mA Signal, the Optidrive will trip and show the fault code 4-20F 500ms after the signal level falls below 3mA.</p> <p>r 20-4 = 20 to 4mA Signal, the Optidrive will run at Preset Speed 1 (P-20) if the signal level falls below 3mA.</p> <p>Ptc-th = Use for motor thermistor measurement, valid with any setting of P-15 that has Input 3 as E-Trip. Trip level: 1.5kΩ, reset 1kΩ.</p>				
P-48	Standby Mode Timer	0.0	60.0	0.0	s
	When standby mode is enabled by setting P-48 > 0.0, the drive will enter standby following a period of operating at minimum speed (P-02) for the time set in P-48. When in Standby Mode, the drive display shows Stndby , and the output to the motor is disabled.				
P-49	PI Control Wake Up Error Level	0.0	100.0	5.0	%
	When the drive is operating in PI Control Mode (P-12 = 5 or 6), and Standby Mode is enabled (P-48 > 0.0), P-49 can be used to define the PI Error Level (E.g. difference between the setpoint and feedback) required before the drive restarts after entering Standby Mode. This allows the drive to ignore small feedback errors and remain in Standby mode until the feedback drops sufficiently.				
P-50	User Output Relay Hysteresis	0.0	100.0	0.0	%
	Sets the hysteresis level for P-19 to prevent the output relay chattering when close to the threshold.				

6.4. P-00 Read Only Status Parameters

Par.	Description	Explanation
P00-01	1st Analog input value (%)	100% = max input voltage
P00-02	2nd Analog input value (%)	100% = max input voltage
P00-03	Speed reference input (Hz / RPM)	Displayed in Hz if P-10 = 0, otherwise RPM
P00-04	Digital input status	Drive digital input status
P00-05	User PI output (%)	Displays value of the User PI output
P00-06	DC bus ripple (V)	Measured DC bus ripple
P00-07	Applied motor voltage (V)	Value of RMS voltage applied to motor
P00-08	DC bus voltage (V)	Internal DC bus voltage
P00-09	Heatsink temperature (°C)	Temperature of heatsink in °C
P00-10	Run time since date of manuf. (Hours)	Not affected by resetting factory default parameters
P00-11	Run time since last trip (1) (Hours)	Run-time clock stopped by drive disable (or trip), reset on next enable only if a trip occurred. Reset also on next enable after a drive power down
P00-12	Run time since last trip (2) (Hours)	Run-time clock stopped by drive disable (or trip), reset on next enable only if a trip occurred (under-volts not considered a trip) – not reset by power down / power up cycling unless a trip occurred prior to power down
P00-13	Trip Log	Displays most recent 4 trips with time stamp
P00-14	Run time since last enable, HH:MM:SS	Run-time clock stopped on drive disable, value reset on next enable
P00-15	DC bus voltage log (V)	8 most recent values prior to trip, 256ms sample time
P00-16	Heatsink temperature log (°C)	8 most recent values prior to trip, 30s sample time
P00-17	Motor current log (A)	8 most recent values prior to trip, 256ms sample time
P00-18	DC bus ripple log (V)	8 most recent values prior to trip, 22ms sample time
P00-19	Internal drive temperature log (°C)	8 most recent values prior to trip, 30 s sample time
P00-20	Internal drive temperature (°C)	Actual internal ambient temperature in °C
P00-21	CAN process data input	Incoming process data (RX PDO1) for CAN: PI1, PI2, PI3, PI4
P00-22	CAN process data output	Outgoing process data (TX PDO1) for CAN: PO1, PO2, PO3, PO4
P00-23	Accumulated time with heatsink > 85°C (Hours)	Total accumulated hours and minutes of operation above heatsink temp of 85°C
P00-24	Accumulated time with drive internal temp > 80°C (Hours)	Total accumulated hours and minutes of operation with drive internal ambient above 80°C
P00-25	Estimated rotor speed (Hz)	In vector control modes, estimated rotor speed in Hz
P00-26	kWh meter / MWh meter	Total number of kWh / MWh consumed by the drive
P00-27	Total run time of drive fans (Hours)	Time displayed in hh:mm:ss. First value displays time in hrs, press up to display mm:ss
P00-28	Software version and checksum	Version number and checksum. "1" on LH side indicates I/O processor, "2" indicates power stage
P00-29	Drive type identifier	Drive rating, drive type and software version codes
P00-30	Drive serial number	Unique drive serial number
P00-31	Motor current Id / Iq	Displays the magnetising current (Id) and torque current (Iq). Press UP to show Iq
P00-32	Actual PWM switching frequency (kHz)	Actual switching frequency used by drive
P00-33	Critical fault counter – O-I	These parameters log the number of times specific faults or errors occur, and are useful for diagnostic purposes
P00-34	Critical fault counter – O-Volts	
P00-35	Critical fault counter – U-Volts	
P00-36	Critical fault counter – O-temp (h/sink)	
P00-37	Critical fault counter – b O-I (chopper)	
P00-38	Critical fault counter – O-hEA _t (control)	
P00-39	Modbus comms error counter	
P00-40	CANbus comms error counter	
P00-41	I/O processor comms errors	
P00-42	Power stage uC comms errors	
P00-43	Drive power up time (life time) (Hours)	Total lifetime of drive with power applied
P00-44	Phase U current offset & ref	Internal value
P00-45	Phase V current offset & ref	Internal value
P00-46	Phase W current offset & ref	Internal value
P00-47	Index 1: Fire mode total active time Index 2: Fire Mode Activation Count	Total activation time of Fire Mode Displays the number of times Fire Mode has been activated
P00-48	Scope channel 1 & 2	Displays signals for first scope channels 1 & 2
P00-49	Scope channel 3 & 4	Displays signals for first scope channels 3 & 4
P00-50	Bootloader and motor control	Internal value

7. Analog and Digital Input Macro Configurations

7.1. Overview

Optidrive E3 uses a Macro approach to simplify the configuration of the Analog and Digital Inputs. There are two key parameters which determine the input functions and drive behaviour:

P-12 Selects the main drive control source and determines how the output frequency of the drive is primarily controlled.

P-15 Assigns the Macro function to the analog and digital inputs.

Additional parameters can then be used to further adapt the settings, e.g.

P-16 Used to select the format of the analog signal to be connected to analog input 1, e.g. 0 – 10 Volt, 4 – 20mA.

P-30 Determines whether the drive should automatically start following a power on if the Enable Input is present.

P-31 When Keypad Mode is selected, determines at what output frequency / speed the drive should start following the enable command, and also whether the keypad start key must be pressed or if the Enable input alone should start the drive.

P-47 Used to select the format of the analog signal to be connected to analog input 2, e.g. 0 – 10 Volt, 4 – 20mA.

7.2. Example Connection Diagrams

The diagrams below provide an overview of the functions of each terminal macro function, and a simplified connection diagram for each.

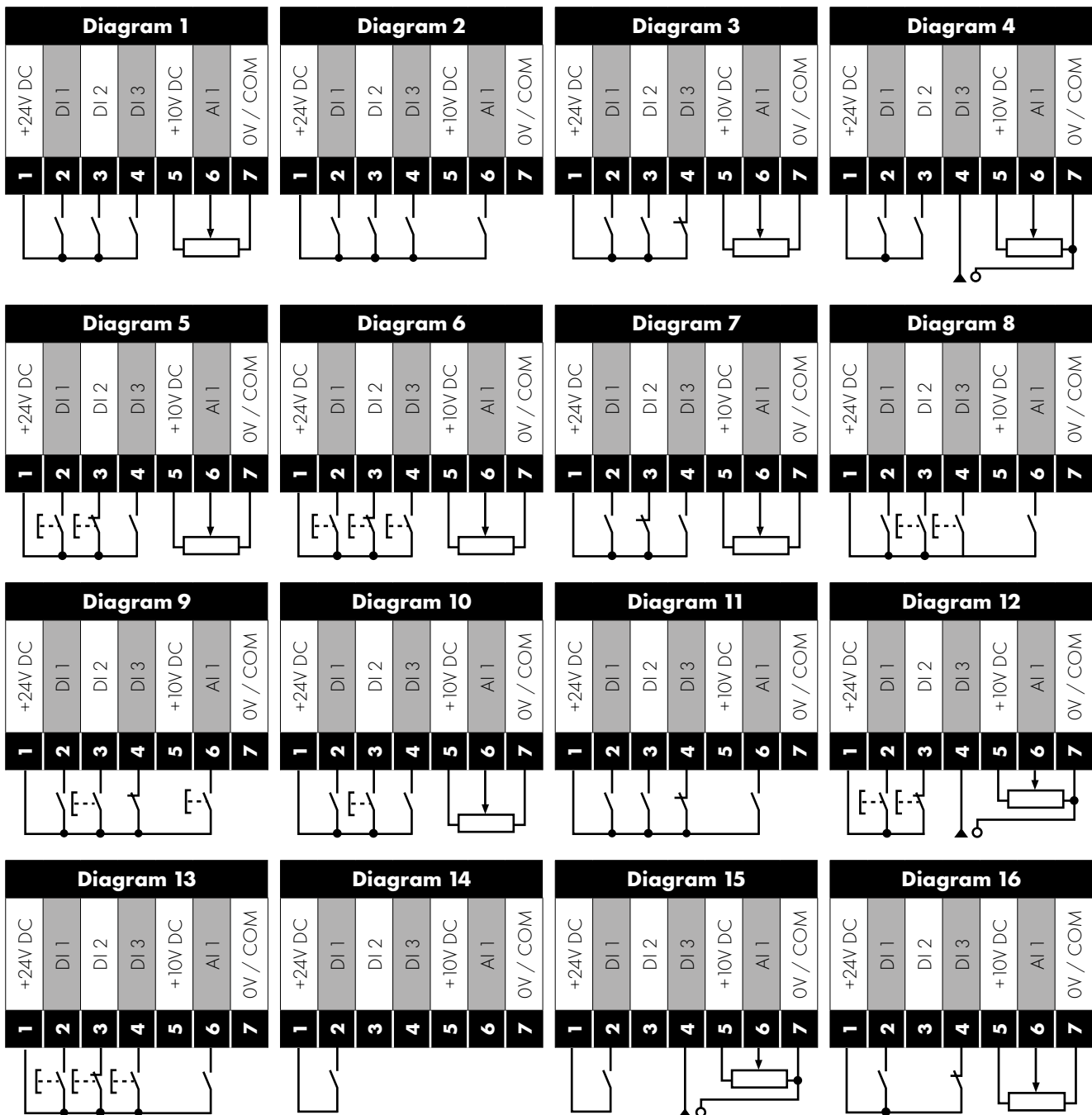

7.3. Macro Functions Guide Key

The table below should be used as a key on the following pages.

Function	Explanation
STOP	Latched Input, Open the contact to STOP the drive
RUN	Latched input, Close the contact to Start, the drive will operate as long as the input is maintained
FWD ↻	Latched Input, selects the direction of motor rotation FORWARD
REV ↻	Latched Input, selects the direction of motor rotation REVERSE
RUN FWD ↻	Latched Input, Close to Run in the FORWARD direction, Open to STOP
RUN REV ↻	Latched Input, Close to Run in the REVERSE direction, Open to STOP
ENABLE	Hardware Enable Input. In Keypad Mode, P-31 determines whether the drive immediately starts, or the keypad start key must be pressed. In other modes, this input must be present before the start command is applied via the fieldbus interface.
START ↑	Normally Open, Rising Edge, Close momentarily to START the drive (NC STOP Input must be maintained)
^ - START - ^	Simultaneously applying both inputs momentarily will START the drive (NC STOP Input must be maintained)
STOP ↓	Normally Closed, Falling Edge, Open momentarily to STOP the drive
START ↑ FWD ↻	Normally Open, Rising Edge, Close momentarily to START the drive in the forward direction (NC STOP Input must be maintained)
START ↑ REV ↻	Normally Open, Rising Edge, Close momentarily to START the drive in the reverse direction (NC STOP Input must be maintained)
^ - FAST STOP (P-24) - ^	When both inputs are momentarily active simultaneously, the drive stops using Fast Stop Ramp Time P-24
FAST STOP ↓ (P-24)	Normally Closed, Falling Edge, Open momentarily to FAST STOP the drive using Fast Stop Ramp Time P-24
E-TRIP	Normally Closed, External Trip input. When the input opens momentarily, the drive trips showing $E-Err$ or $P-Err$ depending on P-47 setting
Fire Mode	Activates Fire Mode
Analog Input AI1	Analog Input 1, signal format selected using P-16
Analog Input AI2	Analog Input 2, signal format selected using P-47
AI1 REF	Analog Input 1 provides the speed reference
AI2 REF	Analog Input 2 provides the speed reference
P-xx REF	Speed reference from the selected preset speed
PR-REF	Preset speeds P-20 – P-23 are used for the speed reference, selected according to other digital input status
PI-REF	PI Control Speed Reference
PI FB	Analog Input used to provide a Feedback signal to the internal PI controller
KPD REF	Keypad Speed Reference selected
FB REF	Selected speed reference from Fieldbus (Modbus RTU / CAN Open / Master depending on P-12 setting)
(NO)	Input is Normally Open, Close momentarily to activate the function
(NC)	Input is Normally Closed, Open momentarily to activate the function
INC SPD ↑	Normally Open, Rising Edge, Close momentarily to increase the motor speed by value in P-20
DEC SPD ↓	Normally Open, Rising Edge, Close momentarily to decrease the motor speed by value in P-20

7.4. Macro Functions – Terminal Mode (P-12 = 0)

P-15	DI1		DI2		DI3 / AI2		DI4 / AI1		Diagram	
	0	1	0	1	0	1	0	1		
0	STOP	RUN	FWD ↻	REV ↻	AI1 REF	P-20 REF	Analog Input AI1		1	
1	STOP	RUN	AI1 REF	PR-REF	P-20	P-21	Analog Input AI1		1	
2	STOP	RUN	DI2	DI3	PR		P-20 - P-23	P-01	2	
			0	0	P-20					
			1	0	P-21					
			0	1	P-22					
			1	1	P-23					
3	STOP	RUN	AI1	P-20 REF	E-TRIP	OK	Analog Input AI1		3	
4	STOP	RUN	AI1	AI2	Analog Input AI2		Analog Input AI1		4	
5	STOP	RUN FWD ↻	STOP	RUN REV ↻	AI1	P-20 REF	Analog Input AI1		1	
		^-----FAST STOP (P-24)-----^								
6	STOP	RUN	FWD ↻	REV ↻	E-TRIP	OK	Analog Input AI1		3	
7	STOP	RUN FWD ↻	STOP	RUN REV ↻	E-TRIP	OK	Analog Input AI1		3	
		^-----FAST STOP (P-24)-----^								
8	STOP	RUN	FWD ↻	REV	DI3	DI4	PR		2	
					0	0	P-20			
					1	0	P-21			
					0	1	P-22			
			1	1	P-23					
9	STOP	START FWD ↻	STOP	START REV ↻	DI3	DI4	PR		2	
					0	0	P-20			
					1	0	P-21			
					0	1	P-22			
			1	1	P-23					
10	(NO)	START ↑	STOP	(NC)	AI1 REF	P-20 REF	Analog Input AI1		5	
11	(NO)	START ↑ FWD ↻	STOP	(NC)	(NO)	START ↓ REV ↻	Analog Input AI1		6	
							^-----FAST STOP (P-24)-----^			
12	STOP	RUN	FAST STOP (P-24)	OK	AI1 REF	P-20 REF	Analog Input AI1		7	
13	(NO)	START FWD ↻	STOP	(NC)	(NO)	START REV ↻	KPD REF	P-20 REF	13	
							^-----FAST STOP (P-24)-----^			
14	STOP	RUN	DI2		E-TRIP	OK	DI2	DI4	PR	11
			0	0			P-20			
			1	0			P-21			
			0	1			P-22			
			1	1	P-23					
15	STOP	RUN	P-23 REF	AI1	Fire Mode		Analog Input AI1		1	
16	STOP	RUN	P-23 REF	P-21 REF	Fire Mode		FWD	REV	2	
17	STOP	RUN	DI2		Fire Mode		DI2	DI4	PR	2
			0	0	P-20					
			1	0	P-21					
			0	1	P-22					
			1	1	P-23					
18	STOP	RUN	FWD ↻	REV ↻	Fire Mode		Analog Input AI1		1	
19	STOP	RUN	AI1 REF	PR1 REF	No Function	Fire Mode	AI1		1	
NOTE	When P-15 = 19, P-30 Index 2 and Index 3 have no effect. When the fire mode input is on, the drive will run regardless of whether the run input is present. Speed reference in Fire Mode is always Preset Speed 4, P-23.									

7.5. Macro Functions - Keypad Mode (P-12 = 1 or 2)

P-15	DI1		DI2		DI3 / AI2		DI4 / AI1		Diagram
	0	1	0	1	0	1	0	1	
0	STOP	ENABLE	-	INC SPD ↑	-	DEC SPD ↓	FWD ↻	REV ↻	8
^-----START-----^									
1	STOP	ENABLE	PI Speed Reference						2
2	STOP	ENABLE	-	INC SPD ↑	-	DEC SPD ↓	KPD REF	P-20 REF	8
^-----START-----^									
3	STOP	ENABLE	-	INC SPD ↑	E-TRIP	OK	-	DEC SPD ↓	9
^-----START-----^									
4	STOP	ENABLE	-	INC SPD ↑	KPD REF	AI1 REF	AI1		10
5	STOP	ENABLE	FWD ↻	REV ↻	KPD REF	AI1 REF	AI1		1
6	STOP	ENABLE	FWD ↻	REV ↻	E-TRIP	OK	KPD REF	P-20 REF	11
7	STOP	RUN FWD	STOP	RUN REV ↻	E-TRIP	OK	KPD REF	P-20 REF	11
		^-----FAST STOP (P-24)-----^							
8	STOP	RUN FWD ↻	STOP	RUN REV ↻	KPD REF	AI1 REF	AI1		1
14	STOP	ENABLE	-	INC SPD ↑	E-TRIP	OK	-	DEC SPD ↓	
15	STOP	ENABLE	PR REF	KPD REF	Fire Mode		P-23	P-21	2
16	STOP	ENABLE	P-23 REF	KPD REF	Fire Mode		FWD ↻	REV ↻	2
17	STOP	ENABLE	KPD REF	P-23 REF	Fire Mode		FWD ↻	REV ↻	2
18	STOP	ENABLE	AI1 REF	KPD REF	Fire Mode		AI1		1
19	STOP	RUN	KPD REF	PR1 REF	No Function	Fire Mode	AI1		1
9, 10, 11, 12, 13 = Behavior as per setting 0									
NOTE	When P15=4 in keypad mode, DI2 & DI4 are edge triggered. Digital pot speed will be increased or decreased once for each rising edge. The step of each speed change is defined by the absolute value of Pre-set Speed 1 (P-20).								
	Speed change only happens during normal running condition (no stop command etc.). Digital pot will be adjusted between minimum speed (P-02) and maximum speed (P-01).								
	When P-15 = 19, P-30 Index 2 and Index 3 have no effect. When the fire mode input is on, the drive will run regardless of whether the run input is present. Speed reference in Fire Mode is always Preset Speed 4, P-23.								

7.6. Macro Functions - Fieldbus Control Mode (P-12 = 3, 4, 7, 8 or 9)

P-15	DI1		DI2		DI3 / AI2		DI4 / AI1		Diagram
	0	1	0	1	0	1	0	1	
0	STOP	ENABLE	FB REF (Fieldbus Speed Reference, Modbus RTU / CAN / Master-Slave defined by P-12)						14
1	STOP	ENABLE	PI Speed Reference						15
2	STOP	ENABLE	PI REF	AI1 REF	Analog Input AI 2		Analog Input AI1		4
		^----START (P-12 = 3 or 4 Only)----^							
3	STOP	ENABLE	FB REF	P-20 REF	E-TRIP	OK	Analog Input AI1		3
5	STOP	ENABLE	FB REF	PR REF	P-20	P-21	Analog Input AI1		1
		^----START (P-12 = 3 or 4 Only)----^							
6	STOP	ENABLE	FB REF	AI1 REF	E-TRIP	OK	Analog Input AI1		3
		^----START (P-12 = 3 or 4 Only)----^							
7	STOP	ENABLE	FB REF	KPD REF	E-TRIP	OK	Analog Input AI1		3
		^----START (P-12 = 3 or 4 Only)----^							
14	STOP	ENABLE	-	-	E-TRIP	OK	Analog Input AI1		16
15	STOP	ENABLE	PR REF	FB REF	Fire Mode		P-23	P-21	2
16	STOP	ENABLE	P-23 REF	FB REF	Fire Mode		Analog Input AI1		1
17	STOP	ENABLE	FB REF	P-23 REF	Fire Mode		Analog Input AI1		1
18	STOP	ENABLE	AI1 REF	FB REF	Fire Mode		Analog Input AI1		1
4, 8, 9, 10, 11, 12, 13, 19 = Behavior as per setting 0									

7.7. Macro Functions - User PI Control Mode (P-12 = 5 or 6)

P-15	DI1		DI2		DI3 / AI2		DI4 / AI1		Diagram
	0	1	0	1	0	1	0	1	
0	STOP	RUN	PI REF	P-20 REF	AI2		AI1		4
1	STOP	RUN	PI REF	AI1 REF	AI2 (PI FB)		AI1		4
3, 7	STOP	RUN	PI REF	P-20	E-TRIP	OK	AI1 (PI FB)		3
4	(NO)	START	(NC)	STOP	AI2 (PI FB)		AI1		12
5	(NO)	START	(NC)	STOP	PI REF	P-20 REF	AI1 (PI FB)		5
6	(NO)	START	(NC)	STOP	E-TRIP	OK	AI1 (PI FB)		
8	STOP	RUN	FWD \curvearrowright	REV \curvearrowleft	AI2 (PI FB)		AI1		4
9	STOP	RUN	FWD \curvearrowright	REV \curvearrowleft	PI REF	PR1 REF	AI1		1
14	STOP	RUN	-	-	E-TRIP	OK	AI1 (PI FB)		16
15	STOP	RUN	P-23 REF	PI REF	Fire Mode		AI1 (PI FB)		1
16	STOP	RUN	P-23 REF	P-21 REF	Fire Mode		AI1 (PI FB)		1
17	STOP	RUN	FWD \curvearrowright	REV \curvearrowleft	E-TRIP	-	AI1		3
18	STOP	RUN	AI1 REF	PI REF	Fire Mode		AI1 (PI FB)		1
2, 9, 10, 11, 12, 13, 19 = Behavior as per setting 0									
NOTE	P1 Setpoint source is selected by P-44 (default is fixed value in P-45, AI 1 may also be selected). P1 Feedback source is selected by P-46 (default is AI 2, other options may be selected).								

7.8. Fire Mode

The Fire Mode function is designed to ensure continuous operation of the drive in emergency conditions until the drive is no longer capable of sustaining operation. The Fire Mode input may be a normally open (Close to Activate Fire Mode) or Normally Closed (Open to Activate Fire Mode) according to the setting of P-30 Index 2. In addition, the input may be momentary or maintained type, selected by P-30 Index 3.

This input may be linked to a fire control system to allow maintained operation in emergency conditions, e.g. to clear smoke or maintain air quality within that building.

The fire mode function is enabled when P-15 = 15, 16 or 17, with Digital Input 3 assigned to activate fire mode.

Fire Mode disables the following protection features in the drive:

$\overline{O-T}$ (Heat-sink Over-Temperature), $\overline{U-T}$ (Drive Under Temperature), $\overline{Eh-FLT}$ (Faulty Thermistor on Heat-sink), $\overline{E-trIP}$ (External Trip), $\overline{4-20F}$ (4-20mA fault), $\overline{Ph-Ib}$ (Phase Imbalance), $\overline{P-LOSS}$ (Input Phase Loss Trip), $\overline{SC-trIP}$ (Communications Loss Trip), $\overline{I-t-trIP}$ (Accumulated overload Trip).

The following faults will result in a drive trip, auto reset and restart:

$\overline{O-volt}$ (Over Voltage on DC Bus), $\overline{U-volt}$ (Under Voltage on DC Bus), $\overline{h-O-I}$ (Fast Over-current Trip), $\overline{O-I}$ (Instantaneous over current on drive output), $\overline{OUL-F}$ (Drive output fault, Output stage trip).

8. Modbus RTU Communications

8.1. Introduction

The Optidrive E3 can be connected to a Modbus RTU network via the RJ45 connector on the front of the drive.

8.2. Modbus RTU Specification

Protocol	Modbus RTU
Error check	CRC
Baud rate	9600bps, 19200bps, 38400bps, 57600bps, 115200bps (default)
Data format	1 start bit, 8 data bits, 1 stop bits, no parity
Physical signal	RS 485 (2-wire)
User interface	RJ45
Supported Function Codes	03 Read Multiple Holding Registers 06 Write Single Holding Register 16 Write Multiple Holding Registers (Supported for registers 1 – 4 only)

8.3. RJ45 Connector Configuration

For full MODBUS RTU register map information please refer to your Invertek Drives Sales Partner. Local contacts can be found by visiting our website:

www.invertekdrives.com

When using MODBUS control the Analog and Digital Inputs can be configured as shown in section 7.6.

Macro Functions - Fieldbus Control Mode (P-12 = 3, 4, 7, 8 or 9) on page 30.

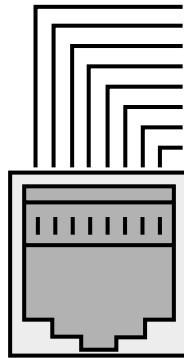

1	CAN -
2	CAN +
3	0 Volts
4	-RS485 (PC)
5	+RS485 (PC)
6	+24 Volt
7	-RS485 (Modbus RTU)
8	+RS485 (Modbus RTU)

Warning: This is not an Ethernet connection. Do not connect directly to an Ethernet port.

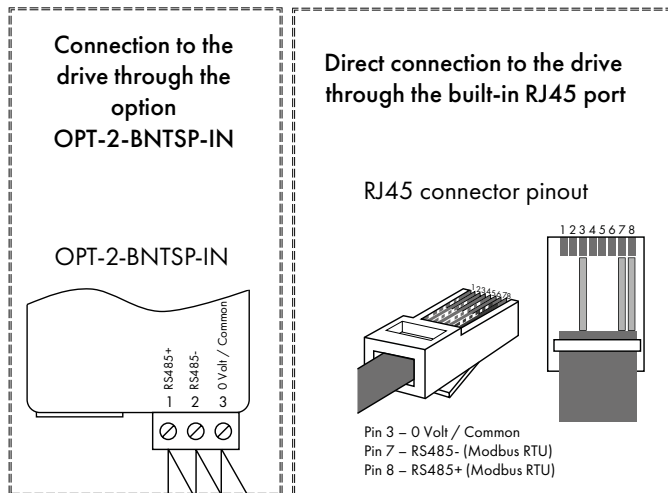

NOTES

- Use 3 or 4 Conductor Twisted Pair Cable
- RS485+ and RS485- must be twisted pair
- Ensure the network taps for the drive are kept as short as possible
- Using Option OPT-2-BNTSP-IN is preferred
- Terminate the network cable shield at the controller only. Do not terminate at the drive!
- 0 Volt common must be connected across all devices and to reference 0 Volt terminal at the controller
- Do not connect the 0V Common of the network to power ground

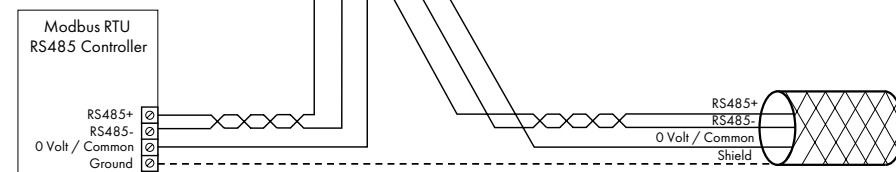

NOTE For Master devices which use zero based addressing and therefore treat the first Register address as Register 0, it may be necessary to convert the Register Numbers detailed below by subtracting 1 to obtain the correct Register address.

8.4. Modbus Register Map

Register Number	Par.	Type	Supported Function Codes			Function		Range	Explanation
			03	06	16	Low Byte	High Byte		
1	-	R/W	✓	✓	✓	PDO0 Control Word		0..3	16 Bit Word. Bit 0: Low = Stop, High = Run Enable Bit 1: Low = Decel Ramp 1 (P-04), High = Decel Ramp 2 (P-24) Bit 2: Low = No Function, High = Fault Reset Bit 3: Low = No Function, High = Coast Stop Request Bit 8: Relay control, 0 = Open, 1 = Close Bit 9 : DO Control, 1 = Off, 0 = On
2	-	R/W	✓	✓	✓	PDO1 Frequency Setpoint		0..5000	Setpoint frequency x10, e.g. 100 = 10.0Hz
3	-	R/W	✓	✓	✓	PI Setpoint/ Analog Output Control		0..4096	0 - 4096 = 0 - 100.0%
4	-	R/W	✓	✓	✓	PDO3		0..60000	Ramp time in seconds x 100, e.g. 250 = 2.5 seconds
6	-	R	✓			Drive status	Error code		Low Byte = Drive Error Code, see section 11.1. Fault Code Messages High Byte = Drive Status as follows: 0: Drive Running 1: Drive Tripped 5: Standby Mode 6: Drive Ready
7		R	✓			Output Motor Frequency		0..20000	Output frequency in Hz x10, e.g. 100 = 10.0Hz
8		R	✓			Output Motor Current		0..480	Output Motor Current in Amps x10, e.g. 10 = 1.0 Amps
11	-	R	✓			Digital input status		0..15	Indicates the status of the 4 digital inputs Lowest Bit = 1 Input 1
20	P00-01	R	✓			Analog Input 1 value		0..1000	Analog input % of full scale x10, e.g. 1000 = 100%
21	P00-02	R	✓			Analog Input 2 value		0..1000	Analog input % of full scale x10, e.g. 1000 = 100%
22	P00-03	R	✓			Speed Reference Value		0..1000	Displays the setpoint frequency x10, e.g. 100 = 10.0Hz
23	P00-08	R	✓			DC bus voltage		0..1000	DC Bus Voltage in Volts
24	P00-09	R	✓			Drive temperature		0..100	Drive heatsink temperature in °C
2001	-	R	✓			Status Word 2			See below
2002	-	R	✓			Motor Output Speed			Speed in Hz with one decimal place
2003	-	R	✓			Motor Output Current			Current in A with one decimal place
2004	-	R	✓			Motor Output Power			Power in kW with one decimal place
2005	-	R	✓			IO Status Word			See below
2006	-	R	✓			Motor Output Torque			0.0% to +/- 200.0%
2007	P00-08	R	✓			DC Bus Voltage			0 – 1000V
2008	P00-09	R	✓			Heatsink Temperature			Temperature in °C
2009	P00-01	R	✓			Analog Input 1			0 ~ 4096 (12bits)
2010	P00-02	R	✓			Analog Input 2			0 ~ 4096 (12bits)
2011	-	R	✓			Analog Output			0.0 to 100.0%
2012	P00-05	R	✓			PI Output			0.0 to 100.0%
2013	P00-20	R	✓			Internal Temperature			Temperature in °C
2014	P00-07	R	✓			Motor Output Voltage			0 – 500V
2015	-	R	✓			IP66 Pot Input value			0 ~ 4096 (12bits)
2016	-	R	✓			Trip Code			See user guide for code definition

All user configurable parameters are accessible as Holding Registers, and can be Read from or Written to using the appropriate Modbus command. The Register number for each parameter P-04 to P-60 is defined as 128 + Parameter number, e.g. for parameter P-15, the register number is 128 + 15 = 143. Internal scaling is used on some parameters, for further details please contact your Invertek Drives Sales Partner.

8.4.1. Drive status and error code Word PD10

Bit	Function When "0"	Function When "1"
15		
14		
13		
12	In the event of a trip, the associated code is shown in this byte	
11		
10		
9		
8		
7		
6	Not Ready	Drive Ready
5		
4		
3		
2	-	Drive In Standby Mode
1	Drive OK	Drive Tripped
0	Drive Stopped	Drive Running

Bit 6: Drive Ready to Run is defined as:

- Not tripped.
- Hardware enable signal present (DI1 ON).
- No mains loss condition.

8.4.2. Register 2001 definition – New Status Word

Bit	Definition	Description
0	Ready	This bit is set if no trip and no mains loss, plus hardware enabled
1	Running	This bit is set when drive is running
2	Tripped	This bit is set when drive is under trip condition
3	Standby	This bit is set when drive is in standby mode
4	Fire Mode	This bit is set if fire mode is active
5	Reserved	Read as 0
6	Speed Set-point Reached (At Speed)	This bit is set when drive is enabled and reaches speed set point
7	Below Minimum Speed	This bit is set when drive is enabled and speed less than P-02
8	Overload	This bit is set if motor current > P-08
9	Mains Loss	This bit is set if mains loss condition happens
10	Heatsink > 85°C	This bit is set if drive heatsink temperature over 85°C
11	Control Board > 80°C	This bit is set if control PCB temperature over 80°C
12	Switching Frequency Reduction	This bit is set if PWM switching frequency foldback is active
13	Reverse Rotation	This bit is set when motor is in reverse rotation (negative speed)
14	Reserved	Read as 0
15	Live Toggle Bit	This bit will toggle each time this register is read

8.4.3. Register 2005 definition – IO Status Word

Bit	Definition	Description
0	DI1 Status	This bit is set when digital input 1 is closed
1	DI2 Status	This bit is set when digital input 2 is closed
2	DI3 Status	This bit is set when digital input 3 (AI-2) is closed
3	DI4 Status	This bit is set when digital input 4 (AI-1) is closed
4, 5	Reserved	Read as 0
6	IP66 Switch FWD	This bit is set when IP66 FWD switch is closed
7	IP66 Switch REV	This bit is set when IP66 REV switch is closed
8	Digital Output Status	This bit is set when digital output is active(24V) or Analog output > 0
9	Relay Output Status	This bit is set when user relay is closed
10, 11	Reserved	Read as 0
12	Analog Input 1 Signal Lost (4-20mA)	This bit is set when analog input 1 signal loss happens (4..20mA)
13	Analog Input 2 signal Lost (4-20mA)	This bit is set when analog input 2 signal loss happens (4..20mA)
14	Reserved	Read as 0
15	IP66 Pot Input > 50%	This bit is set when IP66 integrated pot input value > 50%

9. Technical Data

9.1. Environmental

Operational ambient temperature range	Open Drives	: -10 ... 50°C (frost and condensation free)
Storage ambient temperature range		: -40 ... 60°C
Maximum altitude		: 2000m. Derate above 1000m: 1% / 100m
Maximum humidity		: 95%, non-condensing
Environmental Conditions		: IP20 Optidrive E3 products are designed to operate in 3S2/3C2 environments in accordance with IEC 60721-3-3.

NOTE For UL compliance: the average ambient temperature over a 24 hour period for 200-240V, 2.2kW and 3HP, IP20 drives is 45°C.

9.2. Rating Tables

Frame Size	kW	HP	Input Current	Fuse / MCB (Type B)		Maximum Cable Size		Output Current A	Recommended Brake Resistance Ω
				Non UL	UL	mm ²	AWG		
110 - 115 (+ / - 10%) V 1 Phase Input, 230V 3 Phase Output (Voltage Doubler)									
1	0.37	0.5	7.8	10	10	8	8	2.3	-
1	0.75	1	15.8	25	20	8	8	4.3	-
2	1.1	1.5	21.9	32	30	8	8	5.8	100
200 - 240 (+ / - 10%) V 1 Phase Input, 3 Phase Output									
1	0.37	0.5	3.7	10	6	8	8	2.3	-
1	0.75	1	7.5	10	10	8	8	4.3	-
1	1.5	2	12.9	16	17.5	8	8	7	-
2	1.5	2	12.9	16	17.5	8	8	7	100
2	2.2	3	19.2	25	25	8	8	10.5	60
3	4	5	29.2	40	40	8	8	15.3	50
200 - 240 (+ / - 10%) V 3 Phase Input, 3 Phase Output									
1	0.37	0.5	3.4	6	6	8	8	2.3	-
1	0.75	1	5.6	10	10	8	8	4.3	-
1	1.5	2	9.5	16	15	8	8	7	-
2	1.5	2	8.9	16	15	8	8	7	100
2	2.2	3	12.1	16	17.5	8	8	10.5	60
3	4	5	20.9	32	30	8	8	18	50
3	5.5	7.5	26.4	40	35	8	8	24	50
4	7.5	10	33.3	40	45	16	5	30	15
4	11	15	50.1	63	70	16	5	46	10
5	15	20	54.6	80	70	25	2	61	10
5	18.5	25	64.8	80	80	25	2	72	10
380 - 480 (+ / - 10%) V 3 Phase Input, 3 Phase Output									
1	0.37	0.5	1.7	6	6	8	8	1.2	-
1	0.75	1	3.5	6	6	8	8	2.2	-
1	1.5	2	5.6	10	10	8	8	4.1	-
2	1.5	2	5.6	10	10	8	8	4.1	250
2	2.2	3	7.5	16	10	8	8	5.8	200
2	4	5	11.5	16	15	8	8	9.5	120
3	5.5	7.5	17.2	25	25	8	8	14	100
3	7.5	10	21.2	32	30	8	8	18	100
3	11	15	27.5	40	35	8	8	24	100
4	15	20	34.2	40	45	16	5	30	30
4	18.5	25	44.1	50	60	16	5	39	22
4	22	30	51.9	63	70	16	5	46	22
5	30	40	56.3	80	70	25	2	61	15
5	37	50	67.6	100	90	25	2	72	12

NOTE Cable sizes shown are the maximum possible that may be connected to the drive. Cables should be selected according to local wiring codes or regulations at the point of installation.

9.3. Single Phase Operation of Three Phase Drives

All drive models intended for operation from three phase mains power supply (e.g. model codes ODE-3-xxxxx-3xxx) may be operated from a single phase supply at up to 50% of maximum rated output current capacity.

In this case, the AC power supply should be connected to L1 (L) and L2 (N) power connection terminals only.

9.4. Additional Information for UL Compliance

Optidrive E3 is designed to meet the UL requirements. For an up to date list of UL compliant products, please refer to UL listing NMMS.E226333. In order to ensure full compliance, the following must be fully observed.

Input Power Supply Requirements					
Supply Voltage	200 – 240 RMS Volts for 230 Volt rated units, + /- 10% variation allowed. 240 Volt RMS Maximum.				
	380 – 480 Volts for 400 Volt rated units, + / - 10% variation allowed, Maximum 500 Volts RMS.				
Imbalance	Maximum 3% voltage variation between phase – phase voltages allowed.				
	All Optidrive E3 units have phase imbalance monitoring. A phase imbalance of > 3% will result in the drive tripping. For input supplies which have supply imbalance greater than 3% (typically the Indian sub-continent & parts of Asia Pacific including China) Invertek Drives recommends the installation of input line reactors.				
Frequency	50 – 60Hz + / - 5% Variation				
Short Circuit Capacity	Voltage Rating	Min kW (HP)	Max kW (HP)	Maximum supply short-circuit current	
				5kA RMS (AC)	100kA RMS (AC)
	115V	0.37 (0.5)	1.1 (1.5)	J-Type fuses	J-Type fuses
	230V	0.37 (0.5)	11 (15)	J-Type fuses	J-Type fuses
	230V	15 (20)	18.5 (25)	J-Type fuses	Semiconductor fuse (FWP-100 Bussmann)
	400 / 460V	0.37 (0.5)	22 (30)	J-Type fuses	J-Type fuses
	400 / 460V	30 (40)	37 (50)	J-Type fuses	Semiconductor fuse (FWP-100 Bussmann)
All the drives in the above table are suitable for use on a circuit capable of delivering not more than the above specified maximum short-circuit Amperes symmetrical with the specified maximum supply voltage when protected by fuses as shown above.					
Mechanical Installation Requirements					
All Optidrive E3 units are intended for indoor installation within controlled environments which meet the condition limits shown in section 9.1. <i>Environmental</i> .					
The drive can be operated within an ambient temperature range as stated in section 9.1. <i>Environmental</i> .					
Frame size 4 drives must be mounted in an enclosure in a manner that ensures the drive is protected from 12.7mm (1/2 inch) of deformation of the enclosure if the enclosure impacted.					
Electrical Installation Requirements					
Incoming power supply connection must be according to section 4.3. <i>Incoming Power Connection</i> .					
Suitable Power and motor cables should be selected according to the data shown in section 9.2. <i>Rating Tables</i> and the National Electrical Code or other applicable local codes.					
Motor Cable	75°C copper stranded or similar (90°C for enclosed Nema 4X type drives).				
Power cable connections and tightening torques are shown in sections 3.3. <i>Mechanical Dimensions and Mounting – IP20 Open Units</i> .					
Integral Solid State short circuit protection does not provide branch circuit protection. Branch circuit protection must be provided in accordance with the national electrical code and any additional local codes. Ratings are shown in section 9.2. <i>Rating Tables</i> .					
Transient surge suppression must be installed on the line side of this equipment and shall be rated 480Volt (phase to ground), 480 Volt (phase to phase), suitable for over voltage category iii and shall provide protection for a rated impulse withstand voltage peak of 4kV.					
UL Listed ring terminals / lugs must be used for all bus bar and grounding connections.					
General Requirements					
Optidrive E3 provides motor overload protection in accordance with the National Electrical Code (US).					
<ul style="list-style-type: none"> Where a motor is not fitted, or not utilised, Thermal Overload Memory Retention must be enabled by setting P-60 Index 1 = 1. Where a motor thermistor is fitted and connected to the drive, connection must be carried out according to the information shown in section 4.8.2. <i>Motor Thermistor Connection</i>. 					

9.5. EMC Filter Disconnect

Drives with an EMC filter have an inherently higher leakage current to Ground (Earth). For applications where tripping occurs the EMC filter can be disconnected (on IP20 units only) by completely removing the EMC screw on the side of the product.

Remove the screw as indicated right.

The Optidrive product range has input supply voltage surge suppression components fitted to protect the drive from line voltage transients, typically originating from lightning strikes or switching of high power equipment on the same supply.

When carrying out a HiPot (Flash) test on an installation in which the drive is built, the voltage surge suppression components may cause the test to fail. To accommodate this type of system HiPot test, the voltage surge suppression components can be disconnected by removing the VAR screw. After completing the HiPot test, the screw should be replaced and the HiPot test repeated. The test should then fail, indicating that the voltage surge suppression components are once again in circuit.

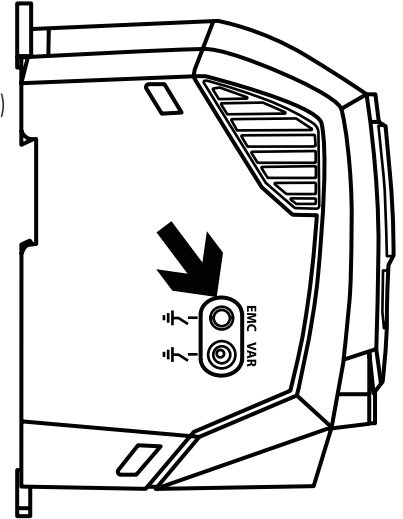

10. Troubleshooting

10.1. Fault Code Messages

Fault Code	No.	Description	Suggested Remedy
no-FLt	00	No Fault	Not required.
Oi-b	01	Brake channel over current	Check external brake resistor condition and connection wiring.
OL-br	02	Brake resistor overload	The drive has tripped to prevent damage to the brake resistor.
O-I	03	Output Over Current	Instantaneous Over current on the drive output. Excess load or shock load on the motor. NOTE Following a trip, the drive cannot be immediately reset. A delay time is inbuilt, which allows the power components of the drive time to recover to avoid damage.
I_t-EP	04	Motor Thermal Overload (I2t)	The drive has tripped after delivering >100% of value in P-08 for a period of time to prevent damage to the motor.
O-UOLt	06	Over voltage on DC bus	Check the supply voltage is within the allowed tolerance for the drive. If the fault occurs on deceleration or stopping, increase the deceleration time in P-04 or install a suitable brake resistor and activate the dynamic braking function with P-34.
U-UOLt	07	Under voltage on DC bus	The incoming supply voltage is too low. This trip occurs routinely when power is removed from the drive. If it occurs during running, check the incoming power supply voltage and all components in the power feed line to the drive.
O-t	08	Heatsink over temperature	The drive is too hot. Check the ambient temperature around the drive is within the drive specification. Ensure sufficient cooling air is free to circulate around the drive.
U-t	09	Under temperature	The drive temperature is below the minimum limit and must be increased to operate the drive.
P-dEF	10	Factory Default parameters loaded	
E-tr IP	11	External trip	E-trip requested on digital input 3. Normally closed contact has opened for some reason. If motor thermistor is connected check if the motor is too hot.
SC-ObS	12	Optibus comms loss	Check communication link between drive and external devices. Make sure each drive in the network has its unique address.
FLt-dc	13	DC bus ripple too high	Check incoming supply phases are all present and balanced.
P-LOSS	14	Input phase loss trip	Check incoming power supply phases are present and balanced.
h O-I	15	Output Over Current	Check for short circuits on the motor and connection cable. NOTE Following a trip, the drive cannot be immediately reset. A delay time is inbuilt, which allows the power components of the drive time to recover to avoid damage.
th-FLt	16	Faulty thermistor on heatsink	
dRAr-F	17	Internal memory fault (IO)	Press the stop key. If the fault persists, consult your supplier.
4-20 F	18	4-20mA Signal Lost	Check the analog input connection(s).
dRAr-E	19	Internal memory fault (DSP)	Press the stop key. If the fault persists, consult your supplier.
F-Ptc	21	Motor PTC thermistor trip	Connected motor thermistor over temperature, check wiring connections and motor.
FAn-F	22	Cooling Fan Fault (IP66 only)	Check / replace the cooling fan.
O-HEAt	23	Drive internal temperature too high	Drive ambient temperature too high, check adequate cooling air is provided.
OUL-F	26	Output Fault	Indicates a fault on the output of the drive, such as one phase missing, motor phase currents not balanced. Check the motor and connections.
AtF-O2	41	Autotune Fault	The motor parameters measured through the autotune are not correct. Check the motor cable and connections for continuity. Check all three phases of the motor are present and balanced.
SC-F01	50	Modbus comms loss fault	Check the incoming Modbus RTU connection cable. Check that at least one register is being polled cyclically within the timeout limit set in P-36 Index 3.
SC-F02	51	CAN comms loss trip	Check the incoming CAN connection cable. Check that cyclic communications take place within the timeout limit set in P-36 Index 3.

NOTE Following an over current or overload trip (3, 4, 15), the drive may not be reset until the reset time delay has elapsed to prevent damage to the drive.

11. Energy Efficiency Classification

Please scan the QR code or visit www.invertekdrives.com/ecodesign to learn more about the Ecodesign Directive and for specific product efficiency classification and part load loss data in accordance with IEC 61800-9-2:2017.



82-E3120-IN_V1.04